



Surgitech Healthcare Private Limited
RESTORING HEALTH

About Surgitech Healthcare Private Limited

Surgitech Healthcare Pvt. Ltd. is an emerging medical device company focused on developing and commercialising innovative, life-enhancing medical technologies, surgical instruments, surgical equipment's and medical devices that help in improving the patient life and surgical outcomes.

The company collaborates with the surgeons and O.R. professionals for developing unique and innovative products to meet their needs.

Surgitech healthcare Pvt Ltd founded in 2015 by budding and hungry team of entrepreneurial minded, motivated team to execute on its bold mission to make super specialised surgery affordable across the world so that no human being, in any corner of the world, should suffer due to the inaccessibility of specialised medical expertise.

Quality is an essential business philosophy. The unmatched quality of our products has fetched us accolades of our discerning clients that are constantly increasing in number. Our workforce comprises of a team of highly skilled and well-trained professionals who look after every aspect of the products.

Our flagship product is redefining the standards of surgeries and also **changing the experience of surgery for people around the world.**

Redesigning Minimal invasive cardiac surgery instruments which is multipurpose & easy to fit any size hand and produce positive patient outcomes.

Our commitment to serving Surgeons, Nurses and ultimately their patients around the world.

Our Vision:

Our vision for ethical and high quality products with all our suppliers, we are constantly offering support to our customers who were regard as partners. With dedicated and full trained sales as well as service terms.

Together with our customers we are driven to make Healthcare better

Authorized Signatory

SURGITECH HEALTHCARE PVT. LTD.

9/102 Geeta colony IInd Floor Delhi 110031 Email: Surgitechhealthcare83@gmail.com

Contact ;09958092223L:9213460672

Website:-- www.surgitechhealthcare.com



Surgitech

CLASSIC, EXCLUSIVE & ELEGANCE STYLE SURGICAL INSTRUMENTS

CONTENTS

	Page No.
CORPORATE PROFILE	1
TITANIUM INSTRUMENTS	
TITANIUM D-DUST MICRO NEEDLE HOLDERS	3-5
TITANIUM RING FORCEPS	6
TITANIUM FORCEPS DEBAKEY	7-9
TITANIUM CLAMPS BABY VASCULAR	10-14
TITANIUM RETRACTOR	15
MICRO FORCEPS	16-17
FORCEPS FINE TO MEDIUM TIPS	18-19
NEEDLE HOLDERS	20-24
SPRING STYLE SCISSORS	25-30
SCISSORS	31-36
SPRING STYLE SCISSORS	37
DISSECTORS / HOOKS / PROBES	38
TUBE PASSER / HOOKS	39
RETRACTORS / HOOKS	40
RETRACTORS	41
RETRACTORS / BAILEY	42
D-DUST MICRO RING FORCEPS TC	43
D-DUST MICRO FORCEPS TC	44
D-DUST CASTROVIEJO NEEDLE HOLDER TC	45
CASTRO VIEJO D-DUST NEEDLE HOLDER TC	46-47
SPECIAL NEEDLE HOLDER TC	48
SHUNT OPERATION INSTRUMENTS	49
D-DUST MICRO NEEDLE HOLDERS TC	50
MICRO NEEDLE HOLDER WITH TC TIPS	51
D-DUST MICRO RING FORCEPS TC	52-53
KIDNEY TRANSPLANT INSTRUMENTS	54-55
INDEX	56
CARE & MAINTENANCE OF INSTRUMENTS	



Surgitech

CLASSIC, EXCLUSIVE & ELEGANCE STYLE SURGICAL INSTRUMENTS

TITANIUM D-DUST
MICRO NEEDLE HOLDERS



Cat. No.	Description
CS 1001	Straight jaws, with ratchet, 43/4" / 12 cm
CS 1001A	Straight jaws, without ratchet, 6" / 15 cm
CS 1002	Straight jaws, with ratchet, 6" / 15 cm
CS 1002A	Curved jaws, with ratchet, 6" / 15 cm

Titanium Needle Holder, D-Dust Jaws with Round Handle

Cat. No.	Description	Recommended suture size: 5-0 and smaller
CS 1003	With ratchet, 9" / 24 cm	



Cat. No.	Description
CS 1004	With ratchet, 8 1/4" / 21 cm
CS 1005	With ratchet, 9 1/2" / 24 cm



Recommended suture size: 7-0 and smaller

Titanium Micro Needle Holder, D-Dust Jaws with Round Handle & Ratchet

Recommended suture size: 5-0 and smaller	Cat. No.	Description
CS 1006	With ratchet, 7 1/4" / 18.5 cm	CS 1009 With ratchet, 10" / 25 cm
CS 1006 A	Without ratchet, 7 1/4" / 18.5 cm	CS 1009 A Without ratchet, 10" / 25 cm
CS 1007	With ratchet, 8" / 20 cm	CS 1010 With ratchet, 12" / 30.5 cm
CS 1007A	Without ratchet, 8" / 20 cm	
CS 1008	With ratchet, 9" / 23 cm	



Titanium Micro Needle Holder, D-Dust Jaws with Round Handle & Ratchet

Recommended suture size: 5-0 and smaller

Cat. No.	Description
CS 1011	With ratchet, 7 1/4" / 18.5 cm
CS 1011 A	Without ratchet, 7 1/4" / 18.5 cm
CS 1012	With ratchet, 8" / 20 cm
CS 1012 A	Without ratchet, 8" / 20 cm
CS 1013	With ratchet, 9" / 23 cm,
CS 1013A	Without ratchet, 9" / 23 cm



Titanium Needle Holder, D-Dust Jaws with Round Handle & Ratchet





Surgitech

CLASSIC, EXCLUSIVE & ELEGANCE STYLE SURGICAL INSTRUMENTS

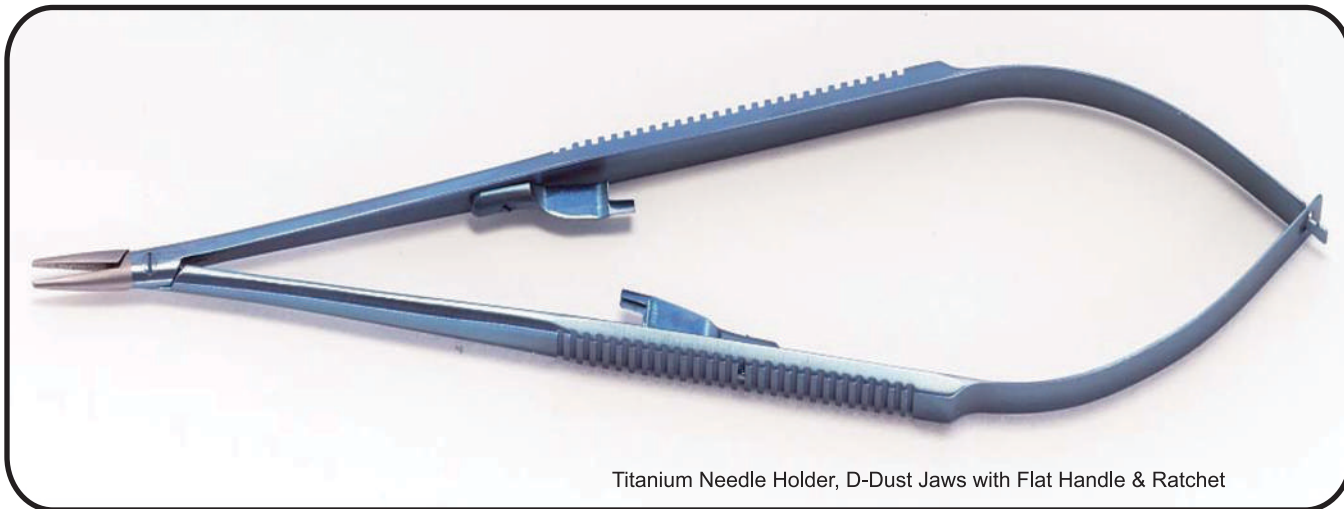
TITANIUM D-DUST
MICRO NEEDLE HOLDERS



Titanium Needle Holder, D-Dust Jaws with Flat Handle & Ratchet

	<p>Recommended suture size: 7-0 and smaller</p> <table border="0"> <tr> <th>Cat. No.</th> <th>Description</th> </tr> <tr> <td>CS 1029</td> <td>With ratchet, 7 1/4" / 18.5 cm</td> </tr> <tr> <td>CS 1030</td> <td>With ratchet, 8 1/4" / 21 cm Jaws, Flat Handle</td> </tr> </table>	Cat. No.	Description	CS 1029	With ratchet, 7 1/4" / 18.5 cm	CS 1030	With ratchet, 8 1/4" / 21 cm Jaws, Flat Handle																					
Cat. No.	Description																											
CS 1029	With ratchet, 7 1/4" / 18.5 cm																											
CS 1030	With ratchet, 8 1/4" / 21 cm Jaws, Flat Handle																											
<p>Recommended suture size: 5-0 and smaller</p> <table border="0"> <tr> <th>Cat. No.</th> <th>Description</th> </tr> <tr> <td>CS 1023</td> <td>With ratchet, 7 1/4" / 18.5 cm</td> </tr> <tr> <td>CS 1023 A</td> <td>Without ratchet, 7 1/4" / 18.5 cm</td> </tr> <tr> <td>CS 1024</td> <td>With ratchet, 8 1/2" / 21.5 cm</td> </tr> <tr> <td>CS 1024 A</td> <td>Fine jaws, with ratchet, 8 1/2" / 21.1 cm</td> </tr> <tr> <td>CS 1024 B</td> <td>Without ratchet, 8 1/2" / 21.1 cm</td> </tr> </table>	Cat. No.	Description	CS 1023	With ratchet, 7 1/4" / 18.5 cm	CS 1023 A	Without ratchet, 7 1/4" / 18.5 cm	CS 1024	With ratchet, 8 1/2" / 21.5 cm	CS 1024 A	Fine jaws, with ratchet, 8 1/2" / 21.1 cm	CS 1024 B	Without ratchet, 8 1/2" / 21.1 cm		<p>Recommended suture size: 7-0 and smaller</p> <table border="0"> <tr> <th>Cat. No.</th> <th>Description</th> </tr> <tr> <td>CS 1025</td> <td>With ratchet, 5 3/4" / 14.5 cm</td> </tr> <tr> <td>CS 1026</td> <td>With ratchet, 7 1/4" / 18.5 cm</td> </tr> <tr> <td>CS 1026 A</td> <td>Without ratchet, 7 1/4" / 18.5 cm</td> </tr> <tr> <td>CS 1027</td> <td>With ratchet, 8 1/4" / 21 cm</td> </tr> <tr> <td>CS 1027 A</td> <td>Without ratchet, 8 1/4" / 21 cm</td> </tr> <tr> <td>CS 1028</td> <td>With ratchet, 9 1/2" / 24 cm</td> </tr> </table>	Cat. No.	Description	CS 1025	With ratchet, 5 3/4" / 14.5 cm	CS 1026	With ratchet, 7 1/4" / 18.5 cm	CS 1026 A	Without ratchet, 7 1/4" / 18.5 cm	CS 1027	With ratchet, 8 1/4" / 21 cm	CS 1027 A	Without ratchet, 8 1/4" / 21 cm	CS 1028	With ratchet, 9 1/2" / 24 cm
Cat. No.	Description																											
CS 1023	With ratchet, 7 1/4" / 18.5 cm																											
CS 1023 A	Without ratchet, 7 1/4" / 18.5 cm																											
CS 1024	With ratchet, 8 1/2" / 21.5 cm																											
CS 1024 A	Fine jaws, with ratchet, 8 1/2" / 21.1 cm																											
CS 1024 B	Without ratchet, 8 1/2" / 21.1 cm																											
Cat. No.	Description																											
CS 1025	With ratchet, 5 3/4" / 14.5 cm																											
CS 1026	With ratchet, 7 1/4" / 18.5 cm																											
CS 1026 A	Without ratchet, 7 1/4" / 18.5 cm																											
CS 1027	With ratchet, 8 1/4" / 21 cm																											
CS 1027 A	Without ratchet, 8 1/4" / 21 cm																											
CS 1028	With ratchet, 9 1/2" / 24 cm																											

Titanium Needle Holder, D-Dust Jaws with Round Handle & Ratchet

Recommended suture size: 7-0 and smaller

Cat. No.	Description
CS 1031	Straight jaws, with ratchet, 8" / 20 cm
CS 1031 A	Straight jaws, without ratchet, 8" / 20 cm
CS 1031 B	Curved jaws, with ratchet, 8" / 20 cm



Titanium Needle Holder, D-Dust Jaws with Round Handle & Ratchet



Surgitech

CLASSIC, EXCLUSIVE & ELEGANCE STYLE SURGICAL INSTRUMENTS

TITANIUM D-DUST
MICRO NEEDLE HOLDERS

Recommended suture size: 6-0 and smaller

Cat. No.	Description
CS 1032	6" / 15 cm
CS 1033	6 3/4" / 17 cm
CS 1034	7 1/2" / 19 cm

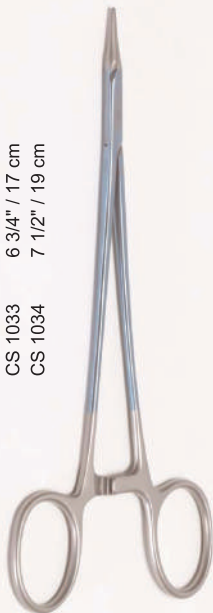

Titanium Micro Needle Holder, Extra Fine D-Dust Jaws & Ring Handle

Recommended suture size: 5-0 and smaller

Cat. No.	Description
CS 1035	6" / 15 cm
CS 1036	6 3/4" / 17 cm
CS 1037	7 1/2" / 19 cm

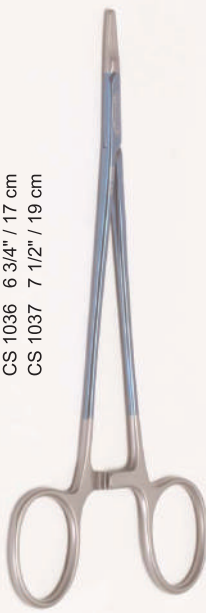

Titanium Ryder Needle Holder, D-Dust with Ring Handle

Recommended suture size: 5-0 and smaller

Cat. No.	Description
CS 1038	7 1/8" / 18.1 cm
CS 1039	8" / 20 cm
CS 1040	8 5/8" / 21.9 cm
CS 1041	10" / 25 cm



Titanium Needle Holder, DeBakey D-Dust Jaws with Ring Handle

Recommended suture size: 5-0 and smaller

Cat. No.	Description
CS 1042	7 1/8" / 18.1 cm
CS 1043	8" / 20 cm
CS 1044	8 5/8" / 21.9 cm
CS 1045	10" / 25 cm

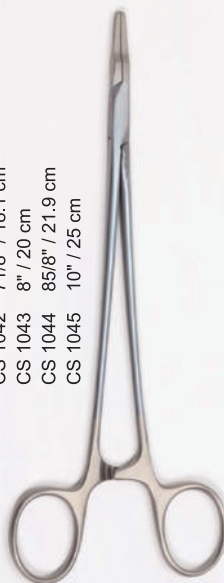

Titanium Needle Holder, Ryder Style D-Dust Jaws with Ring Handle

Recommended suture size: 5-0 and smaller

Cat. No.	Description
CS 1046	7 1/8" / 18.1 cm
CS 1047	8" / 20 cm
CS 1048	8 5/8" / 21.9 cm
CS 1049	10" / 25 cm



Titanium Micro Vascular Needle Holder, D-Dust Jaws with Ring Handle

Recommended suture size: 5-0 and smaller

Cat. No.	Description
CS 1050	Straight jaws, 7 1/4" / 18.5 cm
CS 1050 A	Curved jaws, 7 1/4" / 18.5 cm
CS 1051	Straight jaws, 8 3/4" / 22 cm



Micro Needle Holder, D-Dust Jaws with Ring Handle

Recommended suture size: 2-0 and smaller

Cat. No.	Description
CS 1052	6 1/4" / 16 cm
CS 1053	7 1/8" / 18.1 cm
CS 1056	8" / 20 cm
CS 1057	8 5/8" / 21.9 cm

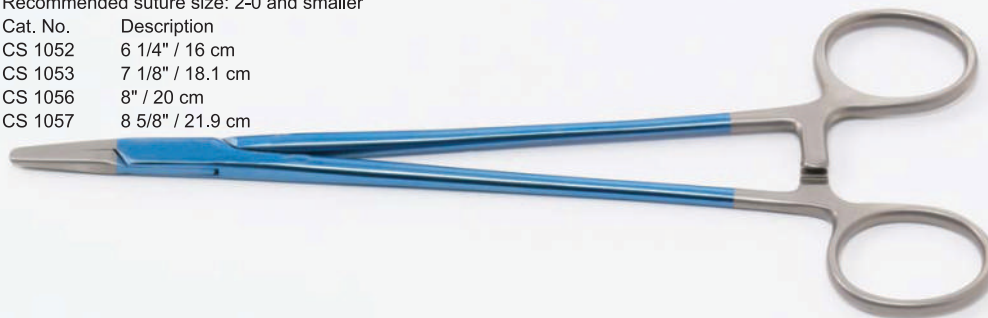

Titanium Mayo-Hegar Needle Holder, D-Dust Jaws with Ring Handle



Surgitech

CLASSIC, EXCLUSIVE & ELEGANCE STYLE SURGICAL INSTRUMENTS

TITANIUM RING
FORCEPS

Micro Forceps, Straight D-DUST Ring Tips, Round Handle

Cat. No.	Description
CS 1101	1 mm ring tip, 6" / 15 cm
CS 1102	1 mm ring tip, 7 1/4" / 18.5 cm
CS 1103	2 mm ring tip, 6" / 15 cm
CS 1104	2 mm ring tip, 7 1/4" / 18.5 cm



Titanium Micro Ring Forceps, D-Dust Jaws with Round Handle

Micro Forceps, 1 mm straight D-DUST Ring Tips, Round Handle, Counter-Balanced

Cat. No.	Description
CS 1105	7" / 18 cm
CS 1106	8 1/4" / 21 cm
CS 1107	9" / 23 cm
CS 1108	10" / 25 cm



Titanium Micro Ring Forceps, D-Dust Jaws with Round Handle & Counter Balanced

Cat. No.	Description
CS 1109	Straight tips, 7 1/8" / 18.1 cm
CS 1110	Straight tips, 8 1/4" / 21 cm
CS 1111	Straight tips, 9" / 23 cm
CS 1112	Straight tips, 10" / 25 cm
CS 1113	Bayonet, straight tips, 8 3/4" / 22 cm



Titanium Micro Platform Ring Forceps, D-Dust Jaws with Round Handle

Cat. No.	Description
CS 1201	Straight tips, 4 3/4" / 12 cm
CS 1202	Straight tips, 6" / 15 cm



Micro Suture Forceps, D-Dust Platform Jaws with Round Handle



Surgitech

CLASSIC, EXCLUSIVE & ELEGANCE STYLE SURGICAL INSTRUMENTS

TITANIUM FORCEPS
DEBAKEY

Cat. No.	Description
CS 1203	Straight tips, 7 1/4" / 18.5 cm
CS 1204	Straight tips, 8 1/4" / 21 cm
CS 1205	Straight tips, 9" / 23 cm
CS 1206	Straight tips, 10" / 25 cm
CS 1203 A	Curved tips, 7 1/4" / 18.5 cm
CS 1204 A	Curved tips, 8 1/4" / 21 cm
CS 1206 A	Curved tips, 10" / 25 cm



Titanium Micro Suture Forceps, D-Dust Jaws Platform Tip with Round Handle

Cat. No.	Cat. No.	Description
0.5 mm Tips	1.0 mm Tips	
CS 1207	CS 1207 A	Straight tips, 7 1/8" / 18.1 cm
CS 1208	CS 1208 A	Straight tips, 8 1/4" / 21 cm
CS 1209	CS 1209 A	Straight tips, 9" / 23 cm
CS 1210	CS 1210 A	Straight tips, 10" / 25 cm
CS 1211	CS 1211 A	Bayonet, straight tips, 8 3/4" / 22 cm



Titanium Micro Suture Forceps, D-Dust Jaws Platform Tip with Round Handle

Cat. No.	Cat. No.	Description
0.5 mm Tips	1.0 mm Tips	
CS 1212		Straight tips, 7 1/8" / 18.1 cm
CS 1213	CS 1213 A	Straight tips, 8 1/4" / 21 cm
CS 1214		Curved tips, 8 1/4" / 21 cm
CS 1215	CS 1215 A	Angled tips, 8 1/4" / 21 cm
CS 1216	CS 1216 A	Straight tips, 9" / 23 cm
CS 1217	CS 1217 A	Straight tips, 10" / 25 cm
CS 1218		Bayonet, Straight tips, 8 3/4" / 22 cm



Titanium Micro Suture Forceps, D-Dust Jaws Platform Tip with Micro Teeth 1X2 & Round Handle

Cat. No.	Description
CS 1219	Straight tips, 7" / 18 cm
CS 1219 A	Curved tips, 7" / 18 cm
CS 1220	Straight tips, 8 1/4" / 21 cm
CS 1220 A	Curved tips, 8 1/4" / 21 cm



Titanium Micro Forceps, D-Dust Jaws Micro Platform Tip with Round Handle & Counter Balanced



Surgitech

CLASSIC, EXCLUSIVE & ELEGANCE STYLE SURGICAL INSTRUMENTS

TITANIUM FORCEPS
DEBAKEY

Cat. No.	Description
CS 1221	7 1/8" / 18.1 cm



Titanium Micro Forceps, D-Dust Jaws, Debakey Tip with Round Handle

Cat. No.	Description
CS 1222	Straight tips, 7 1/8" / 18.1 cm
CS 1223	Straight tips, 8 1/4" / 21 cm
CS 1224	Straight tips, 9" / 23 cm
CS 1225	Straight tips, 10" / 25 cm
CS 1226	Bayonet, straight tips, 8 3/4" / 22 cm



Titanium Micro Forceps, D-Dust Jaws, Tapered Debakey Tip with Round Handle

Cat. No.	Description
CS 1227	0.5 mm D-Dust platform tips
CS 1228	1.0 mm D-Dust platform tips
CS 1227 A	0.5 mm D-Dust with 1x2 micro-teeth
CS 1228 A	1.0 mm D-Dust platform ring tips
CS 1228 B	1.0 mm Tapered DeBaKey tips



Titanium Micro Forceps, D-Dust Jaws, Bayonet Style Platform Tip with Fine Tooth 1X2 & Round Handle

Cat. No.	Description
CS 1231	Delicate 1 x 2 fine teeth, 7" / 18 cm
CS 1231A	D-Dust platform tips, 7" / 18 cm
CS 1232	D-Dust platform tips, 8" / 20 cm



Gerald Forceps, Straight D-Dust Jaws, Flat Handle with Platform / Fine Tooth Tip



Surgitech

CLASSIC, EXCLUSIVE & ELEGANCE STYLE SURGICAL INSTRUMENTS

TITANIUM FORCEPS
DEBAKEY

Cat. No.	Description
CS 1233	7" / 18 cm
CS 1234	8" / 20 cm



Gerald Forceps, Straight D-Dust Jaws, Flat Handle with Debakey Tip

Cat. No.	Description
CS 1235	1 mm tips, 6" / 15 cm
CS 1236	1 mm tips, 7 3/4" / 19.5 cm
CS 1237	1 mm tips, 9 1/2" / 24 cm
CS 1235 A	2 mm tips, 6" / 15 cm
CS 1236 A	2 mm tips, 7 3/4" / 19.5 cm
CS 1237 A	2 mm tips, 9 1/2" / 24 cm



Dissecting Forceps, Straight Debakey Tip, Flat Handle

Cat. No.	Description
CS 1238	7" / 18 cm



Cushing Forceps, Straight Serrated Tips, Fluted Handle

Cat. No.	Description
CS 1239	9" / 23 cm



Ressona Value Forceps, Flat Handle Multi Tooth Tip



Surgitech

CLASSIC, EXCLUSIVE & ELEGANCE STYLE SURGICAL INSTRUMENTS

TITANIUM CLAMPS
BABY VASCULAR

Cat. No.	Description
CS 1301	6 mm jaws, slightly angled shanks, 14 mm jaw length, 4 1/8" / 10.5 cm
CS 1301 A	6 mm jaws, slightly angled shanks, 22 mm jaw length, 4 3/8" / 11.2 cm
CS 1302	6 mm spoon jaws, straight shanks, 14 mm jaw length, 4 1/8" / 10.5 cm
CS 1302 A	6 mm spoon jaws, straight shanks, 26 mm jaw length, 4 5/8" / 11.8 cm
CS 1303	9 mm jaws, slightly angled shanks, 16 mm jaw length, 4 1/8" / 10.5 cm
CS 1303 A	9 mm jaws, slightly angled shanks, 20 mm jaw length, 4 3/8" / 11.2 cm

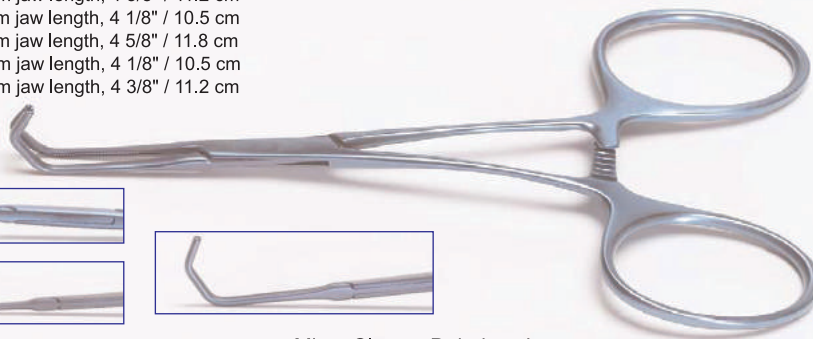
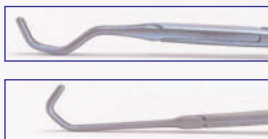
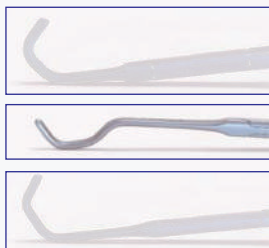

Micro Clamps Debaquey Jaws

Cat. No.	Description
CS 1304	Left angled jaws, 23 mm jaw length, 4 1/4" / 11 cm
CS 1305	Right angled jaws, 23 mm jaw length, 4 1/4" / 11 cm

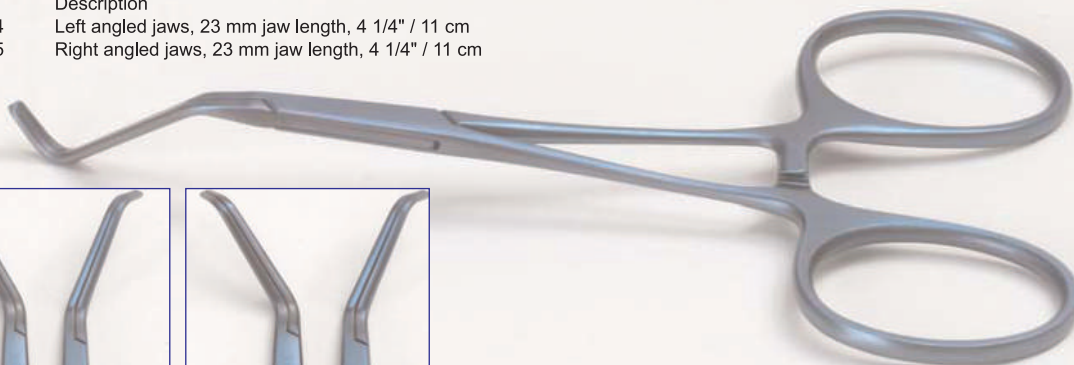
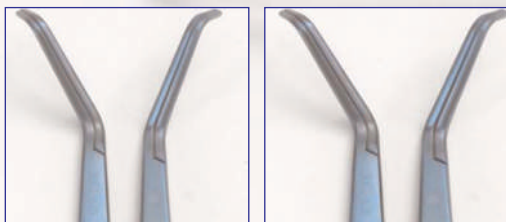

Micro Kitz Miller Clamps Angled Debaquey Jaws

Cat. No.	Description
CS 1306	45° angled jaws, 25 mm jaw length, 4 1/4" / 11 cm
CS 1306 A	45° angled jaws, 30 mm jaw length, 4 1/2" / 11.5 cm
CS 1307	60° angled jaws, 23 mm jaw length, 4 1/8" / 10.5 cm
CS 1307 A	60° angled jaws, 30 mm jaw length, 4 1/4" / 11 cm

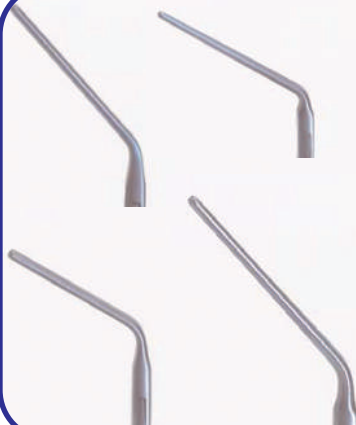

Micro Clamps Angled Debaquey Jaws

Cat. No.	Description
CS 1308	Straight shanks, 30 mm jaw length, 4 3/4" / 12 cm
CS 1308 A	Slightly angled shanks, 30 mm jaw length, 4 3/4" / 12 cm
CS 1308 B	Angled shanks, 22 mm jaw length, 4 1/4" / 11 cm
CS 1308 C	Angled shanks, 30 mm jaw length, 4 5/8" / 11.8 cm

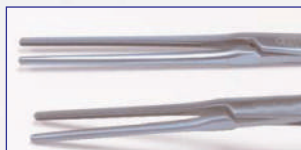

Micro Clamps Straight Debaquey Jaws



Surgitech

CLASSIC, EXCLUSIVE & ELEGANCE STYLE SURGICAL INSTRUMENTS

TITANIUM CLAMPS
BABY VASCULAR

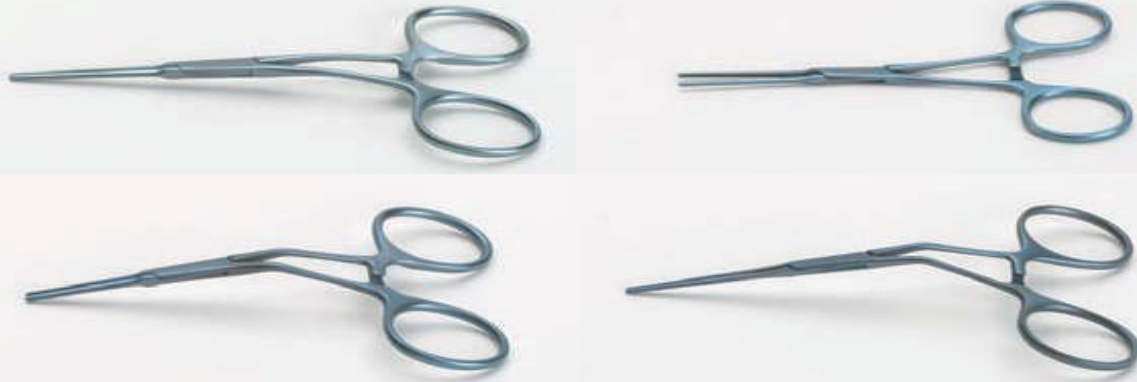

Micro Clamps Straight / Angled Debakey Jaws

Cat. No.	Description
CS 1309	Curved jaws, 6" / 15 cm
CS 1309 A	Slightly curved jaws, 6" / 15 cm



Castaneda Clamps, Cooley Jaws

Cat. No.	Description
CS 1310	Carotid clamp, 7 1/2" / 19 cm



Castaneda Clamps, Double-Angled Calibrated De-Bakey Jaws

Cat. No.	Description
CS1 311	30° angled jaws, 5 1/4" / 13.5 cm
CS1 311 A	50° angled jaws, 5 1/4" / 13.5 cm
CS1 311 B	70° angled jaws, 4 3/4" / 12 cm



Castaneda Clamps, Cooley Jaws



Surgitech

CLASSIC, EXCLUSIVE & ELEGANCE STYLE SURGICAL INSTRUMENTS

TITANIUM CLAMPS
BABY VASCULAR

Cat. No. Description
CS 1312 Peripheral clamp, curved DeBakey jaws, 6" / 15 cm



Peripheral Clamp

Cat. No. Description
CS 1313 Beck infant aorta clamp, De-Bakey jaws, 6 1/2" / 16.5 cm



Beck Infant Aorta Clamp

Cat. No. Description
CS 1314 Subramanian infant aorta clamp, DeBakey jaws, 6 1/4" / 16 cm



Subramanian Infant Aorta Clamp

Cat. No. Description
CS 1315 Kay aorta clamp, 8" / 20 cm



30 mm De-Bakey Jaws



Surgitech

CLASSIC, EXCLUSIVE & ELEGANCE STYLE SURGICAL INSTRUMENTS

TITANIUM CLAMPS
BABY VASCULAR

Cat. No.	Description
CS 1316	Lambert-Kay aorta clamp, 8" / 20 cm



30 mm De-Bakey Jaws

Cat. No.	Description
CS 1317	7.5 cm jaws, 7 3/8" / 18.8 cm



77 mm De-Bakey Jaws

Cat. No.	Description
CS 1318	8 cm jaws, 2 x 3 DeBakey Wide Jaw, 11" / 28 cm

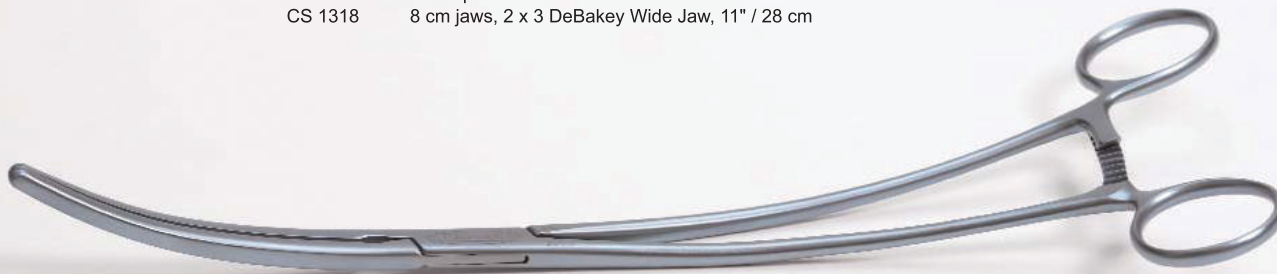

80 mm De-Bakey Jaws

Cat. No.	Description
CS 1319	2 cm jaws, 10" / 25 cm
CS 1320	2.5 cm jaws, 10" / 25 cm
CS 1321	3 cm jaws, 10" / 25 cm



30 mm De-Bakey Jaws



Surgitech

CLASSIC, EXCLUSIVE & ELEGANCE STYLE SURGICAL INSTRUMENTS

TITANIUM CLAMPS
BABY VASCULAR

Cat. No.	Description
CS 1322	3.5 cm jaws, 10" / 25 cm



35 mm De-Bakey Jaws

Cat. No.	Description
CS 1323	5.5 cm curved Cooley jaws, 10" / 25 cm



55 mm Cooley Jaws

Cat. No.	Description
CS 1324	7 cm De-Bakey jaws, 10 1/2" / 27



70 mm De-Bakey Jaws

Cat. No.	Description
CS 1325 A	10° angled, 10 Fr., 3 3/4" 9.5 cm
CS 1325 B	25° angled, 10 Fr., 3 3/4" 9.5 cm
CS 1325 C	45° angled, 10 Fr., 3 3/4" 9.5 cm
CS 1325 D	60° angled, 10 Fr., 3 3/4" 9.5 cm
CS 1326 C	45° angled, 12 Fr., 3 3/4" 9.5 cm
CS 1326 D	60° angled, 12 Fr., 3 3/4" 9.5 cm
CS 1327 C	45° angled, 14 Fr., 3 3/4" 9.5 cm
CS 1327 D	60° angled, 14 Fr., 3 3/4" 9.5 cm



Titanium Bulldog Shunt Clamps



Surgitech

CLASSIC, EXCLUSIVE & ELEGANCE STYLE SURGICAL INSTRUMENTS

MICRO FORCEPS

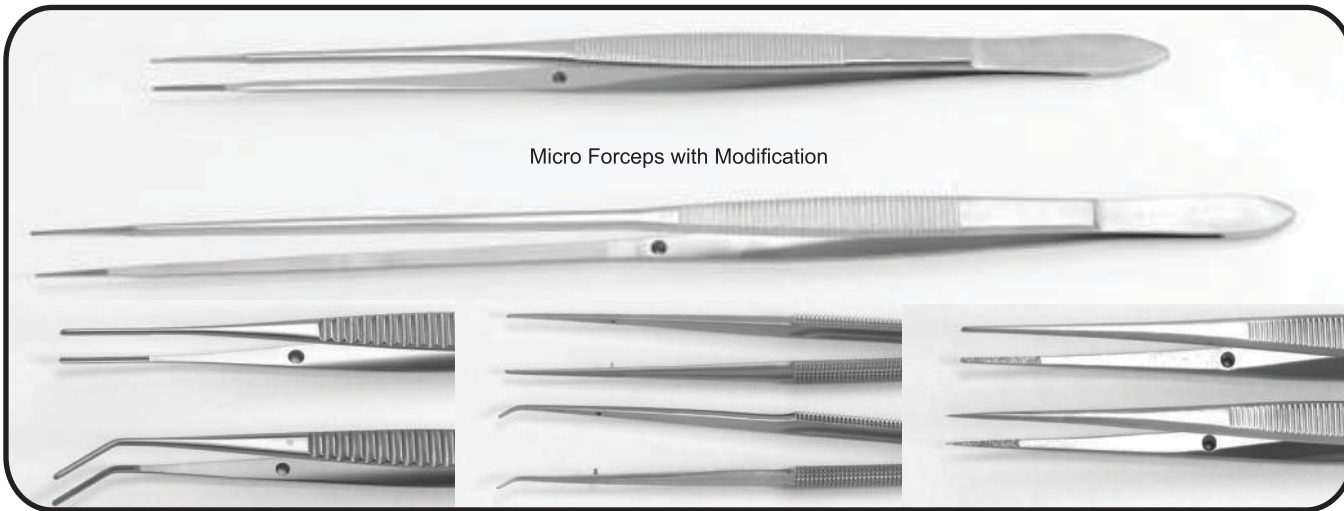

Micro Forceps with Modification

Cat. No.	Description
CS 1114	1 mm straight tips, 6" / 15 cm
CS 1115	1 mm straight tips, 7 1/4" / 18.5 cm
CS 1115 A	1 mm curved tips, 7 1/4" / 18.5 cm
CS 1116	1 mm straight tips, 8 1/4" / 21 cm
CS 1116 A	1 mm curved tips, 8 1/4" / 21 cm
CS 1117	1 mm straight tips, 9" / 23 cm
CS 1117 A	1 mm curved tips, 9" / 23 cm
CS 1118	1 mm straight tips, 10" / 25 cm
CS 1119	2 mm straight tips, 7" / 18 cm
CS 1120	2.5 mm straight tips, 7" / 18 cm

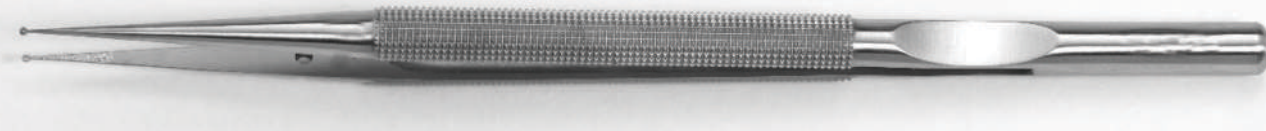

Micro Forceps, D-Dust, Ring Tip, Round Handle, Counter Balanced

Cat. No.	Description
CS 1121	1 mm straight ring tips, 7 1/8" / 18.1 cm
CS 1121 A	1 mm straight platform ring tips, 7 1/8" / 18.1 cm
CS 1122	1 mm straight platform ring tips, 8 1/4" / 21 cm
CS 1123	2.5 mm straight ring tips, 7 1/8" / 18.1 cm
CS 1124	1 mm straight ring tips, 8 1/4" / 21 cm
CS 1122 A	1 mm curved ring tips, 8 1/4" / 21 cm
CS 1123	2.5 mm straight ring tips, 8 1/4" / 21 cm



Light Weight Micro Forceps, D-Dust, Ring Tip with Round Handle



Surgitech

CLASSIC, EXCLUSIVE & ELEGANCE STYLE SURGICAL INSTRUMENTS

MICRO FORCEPS

Cat. No.	Description
CS 1124	1 mm straight ring tips, 7 1/8" / 18.1 cm
CS 1125	1 mm straight platform ring tips, 7 1/8" / 18.1 cm
CS 1126	1 mm straight platform ring tips, 8 1/4" / 21 cm
CS 1127	2.5 mm straight ring tips, 7 1/8" / 18.1 cm
CS 1128	1 mm straight ring tips, 8 1/4" / 21 cm
CS 1126 A	1 mm curved ring tips, 8 1/4" / 21 cm
CS 1129	2.5 mm straight ring tips, 8 1/4" / 21 cm



Light Weight Forceps, D-Dust Tips with Round Handle

Cat. No.	Description
CS 1240	Straight tips, 7 1/8" / 18.1 cm
CS 1240 A	Curved tips, 7 1/8" / 18.1 cm
CS 1241	Straight tips, 8 1/4" / 21 cm
CS 1241 A	Curved tips, 8 1/4" / 21 cm
CS 1240 B	1 mm straight ring tips, 7 1/8" / 18.1 cm
CS 1241 B	1 mm straight ring tips, 8 1/4" / 21 cm
CS 1240 C	Straight tips, 1 x 2 teeth, 7 1/8" / 18.1 cm



Light Weight Forceps, D-Dust Platform Tips with Round Handle

Cat. No.	Description
4004-210	Straight tips, 6" / 15 cm
4004-95	Straight tips, 7" / 18 cm
4004-96	Curved tips, 7" / 18 cm
4004-98	Straight tips, 8 1/4" / 21 cm
4004-99	Curved tips, 8 1/4" / 21 cm
4004-204	Straight tips, 10" / 25 cm
4004-206	Curved tips, 10" / 25 cm
4004-305	Straight tips, 1 x 2 teeth, 7" / 18 cm



D-Dust Platform Tips with Round Handle & Counter Balanced Forceps



Surgitech

CLASSIC, EXCLUSIVE & ELEGANCE STYLE SURGICAL INSTRUMENTS

FORCEPS FINE TO MEDIUM TIPS

Cat. No.	Description
CS 1241	1 mm serrated tips, 7" / 18 cm
CS 1242	1 mm cross-serrated tips, 7 3/4" / 19.5 cm
CS 1243	1 mm cross-serrated tips, 10" / 25 cm
CS 1244	1.5 mm cross-serrated tips, 12" / 30.5 cm



Gerald Forceps, Straight Tips, Flat Handle

Cat. No.	Description
CS 1245	Straight tips, delicate 1 x 2 teeth, 7" / 18 cm
CS 1245 A	1 mm straight DeBakey tips, 7" / 18 cm
CS 1246	1 mm straight DeBakey tips, 8" / 20 cm
CS 1245B	1 mm straight DIAMOND DUST™ ring tips, 7" / 18 cm
CS 1245C	1 mm straight DIAMOND DUST™ platform tips, 7" / 18 cm
CS 1245D	1 mm straight DIAMOND DUST™ tips, 7" / 18 cm
CS 1246D	1 mm straight DIAMOND DUST™ tips, 8" / 20 cm



Gerald Forceps, Straight, D-Dust/DeBakey Tips

Cat. No.	Description
CS 1247	7 1/8" / 18.1 cm
CS 1248	8 1/4" / 21 cm



Light Weight Micro Forceps, Straight DeBakey Tips with Round Handle

Cat. No.	Description
CS 1249	7" / 18 cm
CS 1250	8 1/4" / 21 cm

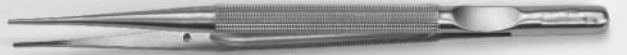

Micro Forceps, Straight DeBakey Tips with Round Handle & Counter Balanced

Cat. No.	Description
CS 1251	7" / 18 cm
CS 1252	8" / 20 cm



Gerald De-Bakey Forceps, Straight Tips with Flat Handle

Cat. No.	Description
CS 1253	1 mm straight tips, 6" / 15 cm
CS 1254	2 mm straight tips, 6" / 15 cm
CS 1255	1 mm straight tips, 7 3/4" / 19.5 cm
CS 1256	1 mm straight tips, fluted handle, 7 3/4" / 19.5 cm
CS 1257	2 mm straight tips, 7 3/4" / 19.5 cm
CS 1258	2.7 mm straight tips, 7 3/4" / 19.5 cm
CS 1259	2 mm straight tips, fluted handle, 7 3/4" / 19.5 cm
CS 1260	2 mm 25° angled tips, 7 3/4" / 19.5 cm
CS 1261	1.5 mm straight tips, 9 1/2" / 24 cm
CS 1262	2 mm straight tips, 9 1/2" / 24 cm
CS 1263	2.7 mm straight tips, 9 1/2" / 24 cm
CS 1264	3.2 mm straight tips, 9 1/2" / 24 cm
CS 1265	1.5 mm straight tips, 12" / 30.5 cm
CS 1266	2 mm straight tips, 12" / 30.5 cm



De-Bakey Forceps, Flat Handle



De-Bakey Forceps, Flat Handle

Cat. No.	Description
CS 1267	2 mm tips, 7 1/4" / 18.5 cm
CS 1268	Fine tips, 7 1/4" / 18.5 cm
CS 1269	Fine tips, 8 1/4" / 21 cm



Light Weight De-Bakey Needle Pulling Tissue Forceps, with Micro Carbon Tips & Round Handle



Surgitech

CLASSIC, EXCLUSIVE & ELEGANCE STYLE SURGICAL INSTRUMENTS

FORCEPS FINE TO MEDIUM TIPS

Cat. No.	Description
CS 1270	7 1/2" / 19 cm



Light Weight De-Bakey Needle Pulling Tissue Forceps, with Micro Carbon Tips & Flat Handle

Cat. No.	Description
CS 1271	7" / 18 cm
CS 1272	8 1/4" / 21 cm
CS 1273	10" / 25 cm



Cushing Forceps, Straight Carbon Tips & Flat Handle

Cat. No.	Description
CS 1274	8" / 20 cm



Brophy Forceps, Fine Teeth Tips 1X2 & Flat Handle

Cat. No.	Description
CS 1275	2 mm tips, 6" / 15 cm
CS 1276	Fine 1x 2 teeth, 6 1/4" / 15.5 cm



McIndoe Forceps, Straight Serrated Tips, Flat Handle

Cat. No.	Description
CS 1277	1 mm DIAMOND DUST™ tips, 8" / 20 cm



Gillies Thumb Forceps, Straight Tips & Flat Handle

Cat. No.	Description
CS 1278	1 mm tips, 6 1/4" / 16 cm
CS 1279	1 mm tips, 7 3/8" / 18.8 cm
CS 1280	2 mm tips, 7 3/8" / 18.8 cm
CS 1281	1 mm tips, 8" / 20 cm
CS 1282	2 mm tips, 8" / 20 cm
CS 1283	1 mm tips, 9 3/4" / 24.2 cm
CS 1284	2 mm tips, 9 3/4" / 24.2 cm



Thumb Forceps, Straight D-Dust Tips, Flat Handle

Cat. No.	Description
CS 1285	Straight tips, 4 1/4" / 11 cm
CS 1286	Straight DIAMOND DUST™ tips, 4 1/4" / 11 cm
CS 1287	Straight tips, 5 1/8" / 13 cm
CS 1288	Straight DIAMOND DUST™ tips, 5 1/8" / 13 cm
CS 1289	45° angled DIAMOND DUST™ tips, 5 1/8" / 13 cm



Jewellers Forceps, Sharp Flat Tips, Flat Handle

Cat. No.	Description
CS 1290	Straight tips, 4 3/4" / 12 cm
CS 1290 A	Curved tips, 4 3/4" / 12 cm
CS 1291	Straight tips, 5 1/2" / 14 cm
CS 1291 A	Curved tips, 5 1/2" / 14 cm

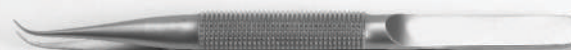

Suture Forceps, D-Dust Flatform Tips, Round Handle



Surgitech

CLASSIC, EXCLUSIVE & ELEGANCE STYLE SURGICAL INSTRUMENTS

FORCEPS FINE TO
MEDIUM TIPS

Cat. No.	Description
CS 1292 A	1.2 mm serrated tips, 4 3/4" / 12 cm
CS 1292 B	1.2 mm DIAMOND DUST™ tips, 4 3/4" / 12 cm
CS 1292 C	1.2 mm platform tips, 1 x 2 teeth, 4 3/4" / 12 cm
CS 1292 D	1.2 mm tips, 1 x 2 teeth, 4 3/4" / 12 cm



Adson Forceps, Straight Tips, Flat Handle

Cat. No.	Description
CS 1293 A	Straight serrated tips, 6" / 15 cm
CS 1293 B	Straight tips, 1 x 2 teeth, 6" / 15 cm



Broli-Adson Forceps, Straight Serrated/Fine Tooth 1X2 Tips, Flat Handle

Cat. No.	Description
CS 1294	9" / 23 cm



Resano Valve Forceps, Multi-Toothed, Flat Handle

Cat. No.	Description
CS 1295	Potts-Smith Forceps, straight serrated tips, 8" / 20 cm
CS 1296	DeBakey Forceps, straight tips, 8 1/2" / 21.5 cm
CS 1297	Broli-Adson Forceps, 1.2 mm straight serrated tips, 6 3/4" / 17 cm

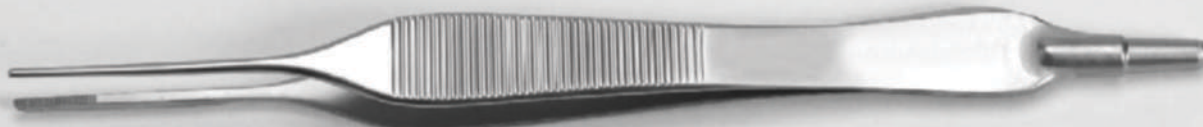

Suction Forceps, One Suction Cannula, Straight Serrated / De-Bakey / Fine Teeth 1X2 Tips



Surgitech

CLASSIC, EXCLUSIVE & ELEGANCE STYLE SURGICAL INSTRUMENTS

NEEDLE HOLDERS

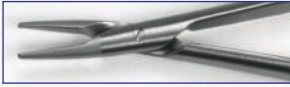

Needle Holder with Round Handle Modifications

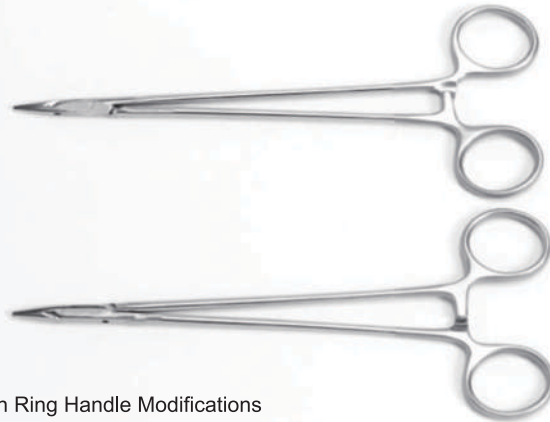

Needle Holder with Ring Handle Modifications

Cat. No.	Description
CS 1058	Straight jaws, 4 7/8" / 12.4 cm
CS 1059	Curved jaws, 7" / 18 cm

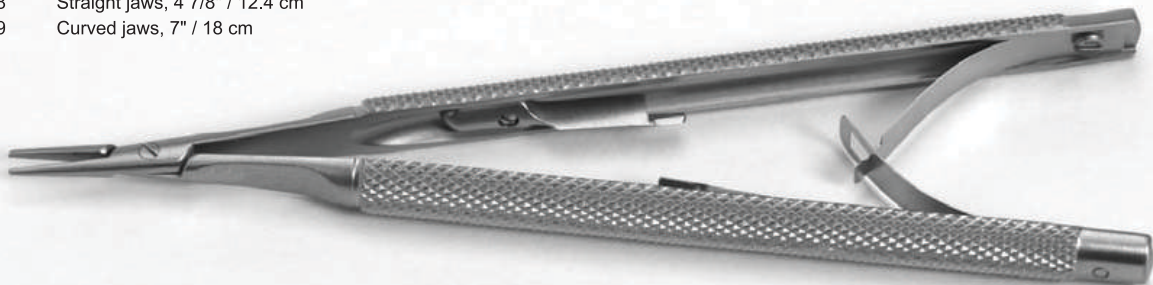

Glasser Micro Needle Holder, Inside Spring, D-Dust Jaws with Ratchet, Round Handle

Cat. No.	Description
CS 1060	Straight jaws, with ratchet



Castroviejo Micro Needle Holders, D-Dust Jaws, Regular Box Lock, Round Handle



Surgitech

CLASSIC, EXCLUSIVE & ELEGANCE STYLE SURGICAL INSTRUMENTS

NEEDLE HOLDERS

Cat. No.	Description
CS 1061	Straight jaws, with ratchet
CS 1061 A	Straight jaws, without ratchet
CS 1062	Curved jaws, with ratchet
CS 1062 A	Curved jaws, without ratchet



Castroviejo Micro Needle Holders, D-Dust Jaws, Regular Box Lock, Round Handle

Cat. No.	Description
CS 1063	Straight jaws, with ratchet
CS 1063 A	Straight jaws, without ratchet
CS 1064	Curved jaws, with ratchet



Jacobson Micro Needle Holders, D-Dust Jaws, Regular Box Lock, Round Handle

Cat. No.	Description
CS 1065	Straight jaws, with ratchet
CS 1065 A	Straight jaws, without ratchet
CS 1066	Curved jaws, with ratchet
CS 1066 A	Curved jaws, without ratchet



Jacobson Micro Needle Holders, D-Dust Jaws, Regular Box Lock, Round Handle

Cat. No.	Description
CS 1067	Straight jaws, with ratchet
CS 1067 A	Straight jaws, without ratchet
CS 1068	Curved jaws, with ratchet
CS 1068 A	Curved jaws, without ratchet



Jacobson Micro Needle Holders, D-Dust Jaws, Regular Box Lock, Round Handle

Cat. No.	Description
CS 1069	Straight jaws, with ratchet
CS 1069 A	Straight jaws, without ratchet
CS 1070	Curved jaws, with ratchet

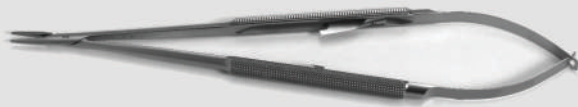

Jacobson Micro Needle Holders, D-Dust Jaws, Regular Box Lock, Round Handle

Cat. No.	Description
CS 1071	Straight jaws, with ratchet
CS 1071 A	Straight jaws, without ratchet
CS 1072	Curved jaws, with ratchet



Jacobson Micro Needle Holders, D-Dust Jaws, Short Knyrling, Round Handle

Cat. No.	Description
CS 1073	Straight jaws, with ratchet
CS 1073 A	Straight jaws, without ratchet
CS 1074	Curved jaws, with ratchet



Jacobson Micro Needle Holders, D-Dust Jaws, Regular Box Lock, Round Handle

Cat. No.	Description
CS 1075	Straight jaws, with ratchet, 7 1/2" / 19 cm
CS 1076	Straight jaws, with ratchet, 9" / 23 cm
CS 1077	Curved jaws, with ratchet, 9" / 23 cm
CS 1078	Straight jaws, with ratchet, 10" / 25 cm



Jacobson Micro Needle Holders, D-Dust Jaws, Round Handle



Surgitech

CLASSIC, EXCLUSIVE & ELEGANCE STYLE SURGICAL INSTRUMENTS

Cat. No.	Description
CS 1079	Straight jaws, with ratchet
CS 1080	Curved jaws, with ratchet



Castroviejo Micro Needle Holders, D-Dust Jaws, Regular Box Lock, Flat Handle

Cat. No.	Description
CS 1081	Straight jaws, with ratchet
CS 1081 A	Straight jaws, without ratchet



Jacobson Micro Needle Holders, D-Dust Jaws, Regular Box Lock, Flat Handle

Cat. No.	Description
CS 1082	Straight jaws, with ratchet
CS 1082 A	Straight jaws, without ratchet
CS 1083	Curved jaws, with ratchet



Jacobson Micro Needle Holders, D-Dust Jaws, Regular Box Lock, Flat Handle

Cat. No.	Description
CS 1084	Straight jaws, with ratchet, 8 1/4" / 21 cm
CS 1084 A	Straight jaws, without ratchet, 8 1/4" / 21 cm
CS 1084 B	Curved jaws, with ratchet, 8 1/4" / 21 cm
CS 1085	Straight jaws, with ratchet, 9 1/2" / 24 cm
CS 1085 A	Straight jaws, without ratchet, 9 1/2" / 24 cm
CS 1085 B	Curved jaws, with ratchet, 9 1/2" / 24 cm



Jacobson Micro Needle Holders, D-Dust Jaws, Regular Box Lock, Flat Handle

Cat. No.	Description
CS 1086	Straight jaws, with ratchet, 7 1/4" / 18.5 cm
CS 1087	Straight jaws, with ratchet, 8" / 20 cm
CS 1087 A	Straight jaws, without ratchet, 8" / 20 cm
CS 1087 B	Curved jaws, with ratchet, 8" / 20 cm
CS 1088	Straight jaws, with ratchet, 9" / 23 cm



Jacobson Micro Needle Holders, D-Dust Jaws, Regular Box Lock, Flat Knurled Handle



Surgitech

CLASSIC, EXCLUSIVE & ELEGANCE STYLE SURGICAL INSTRUMENTS

NEEDLE HOLDERS

Cat. No.	Description
CS 1091	5 1/8" / 13 cm
CS 1091 A	Offset bows, 5 1/8" / 13 cm

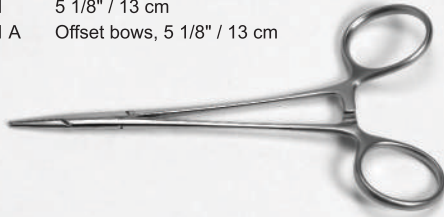

Webster Needle Holders, Straight Delicate D-Dust Jaws, Ring Handle

Cat. No.	Description
CS 1092	4 3/4" / 12 cm



Kaye Needle Holders/Scissors, Straight D-Dust Jaws, Ring Handle

Cat. No.	Description
CS 1093	7" / 18 cm

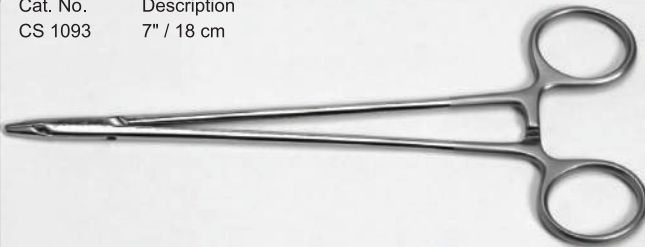

Delicate Needle Holders, Straight D-Dust Jaws, Ring Handle

Cat. No.	Description
CS 1094	1.5 mm jaws, 6 1/4" / 16 cm
CS 1095	1.2 mm jaws, 6 1/4" / 16 cm
CS 1095 A	1.2 mm jaws, 7 1/4" / 18.5 cm
CS 1095 B	1.2 mm jaws, 8 3/4" / 22 cm
CS 1095 C	1.2 mm jaws, 10" / 25 cm



Micro Needle Holders, Ryder-Style, Straight D-Dust Jaws, Ring Handle

Cat. No.	Description
CS 1096	Straight jaws, 5" / 12.7 cm
CS 1097	Straight jaws, 5 3/4" / 14.5 cm
CS 1098	Straight jaws, 6 1/4" / 16 cm
CS 1099	Straight jaws, 7 1/4" / 18.5 cm
CS 10100	Straight jaws, 8 3/4" / 22 cm
CS 10101	Straight jaws, 10" / 25 cm

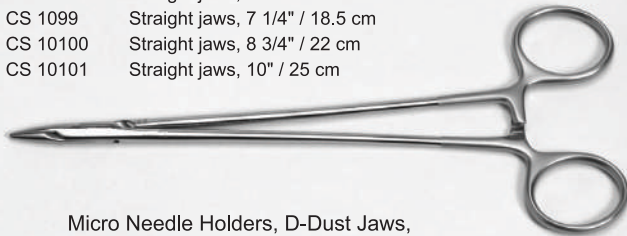

Micro Needle Holders, D-Dust Jaws, Ring Handle

Cat. No.	Description
CS 10102	6" / 15 cm
CS 10102 A	7" / 18 cm
CS 10102 B	8" / 20 cm
CS 10102 C	8 1/2" / 21.5 cm
CS 10102 D	10 1/2" / 27 cm
CS 10102 E	11 3/4" / 29.8 cm

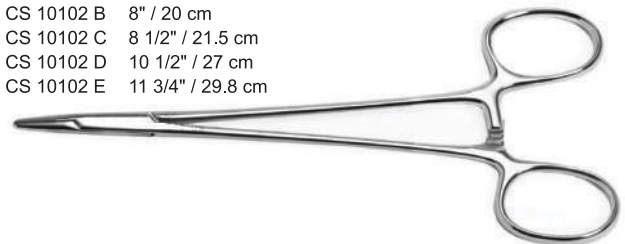

Fell Needle Holders, Straight Carbon Jaws, Round Handle

Cat. No.	Description
CS 10103	Straight jaws, 7 1/4" / 18.5 cm
CS 10104	Straight jaws, 8 1/8" / 20.1 cm
CS 10105	Straight jaws, 9 1/8" / 23.5 cm

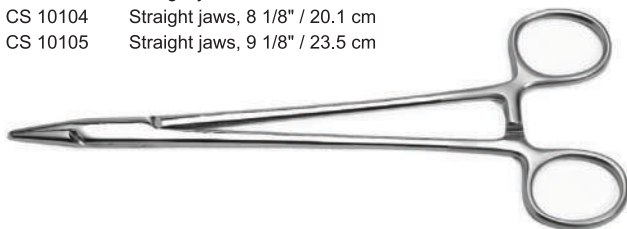

Heavy Style Needle Holders, D-Dust Jaws, Ring Handle

Cat. No.	Description
CS 10106	7" / 18 cm

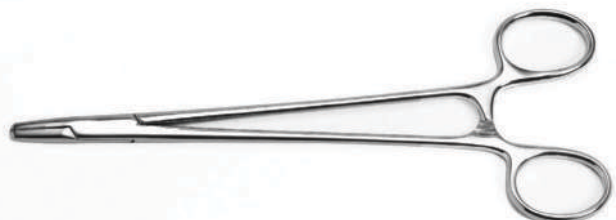

Sternal Needle Holders, Carbon Jaws, Ring Handle



Surgitech

CLASSIC, EXCLUSIVE & ELEGANCE STYLE SURGICAL INSTRUMENTS

SPRING STYLE
SCISSORS

Cat. No.	Description
CS 1401 A	25° angled blades, 4 1/2" / 11.5 cm
CS 1401 B	45° angled blades, 4 1/2" / 11.5 cm
CS 1401 C	60° angled blades, 4 1/2" / 11.5 cm
Cs1401 D	90° angled blades, 4 1/4" / 11 cm
Cs1401 E	125° angled blades, 4 1/4" / 11 cm



Castroviejo Micro Scissors, Round Handle, Angled Fine Blades

Cat. No.	Description
1402 A	25° angled blades, 4 1/4" / 11 cm
1402 B	45° angled blades, 4 1/4" / 11 cm
1402 C	60° angled blades, 4 1/4" / 11 cm
1402 D	90° angled blades, 4 1/8" / 10.5 cm
1402 E	125° angled blades, 4 1/8" / 10.5 cm



Castroviejo Micro Scissors, Round Handle, Angled Micro Fine Blades

Cat. No.	Description
CS 1403 A	25° angled blades, 6 3/4" / 17 cm
CS 1403 B	45° angled blades, 6 3/4" / 17 cm
CS 1403 C	60° angled blades, 6 3/4" / 17 cm
CS 1404 D	90° angled blades, 6 1/2" / 16.5 cm
CS 1404 E	V-neck, 125° angled blades, 6 1/2" / 16.5 cm



Micro Scissors, Round Handle, Angled Nano Blades

Cat. No.	Description
CS 1405 A	25° angled blades, 7" / 18 cm
CS 1405 B	45° angled blades, 7" / 18 cm
CS 1405 C	60° angled blades, 7" / 18 cm
CS 1405 D	90° angled blades, 7" / 18 cm
CS 1406 E	125° angled blades, 6 1/2" / 16.5 cm



Micro Scissors, Round Handle, Angled Fine Blades



Surgitech

CLASSIC, EXCLUSIVE & ELEGANCE STYLE SURGICAL INSTRUMENTS

SPRING STYLE
SCISSORS

Cat. No.	Description
CS 1407 A	25° angled blades, 6 3/4" / 17 cm
CS 1407 B	45° angled blades, 6 3/4" / 17 cm
CS 1407 C	60° angled blades, 6 3/4" / 17 cm
CS 1408 D	90° angled blades, 6 1/2" / 16.5 cm
CS 1408 E	125° angled blades, 6 1/2" / 16.5 cm

Cat. No.	Description
CS 1409 E	6 1/2" / 16.5 cm
CS 1410 E	8" / 20 cm



Micro Scissors, Round Handle, V-neck, 125°Angled Micro Fine Blades
Micro Scissors, Round Handle, Angled Micro Fine Blades

Cat. No.	Description
CS 1411 A	Straight blades, blunt tips, 4 1/4" / 11 cm
CS 1412	Straight blades, sharp tips, 5 1/2" / 14 cm
CS 1412 A	Straight blades, blunt tips, 5 1/2" / 14 cm
CS1413	Curved blades, sharp tips, 5 1/2" / 14 cm
CS 1413 A	Curved blades, blunt tips, 5 1/2" / 14 cm

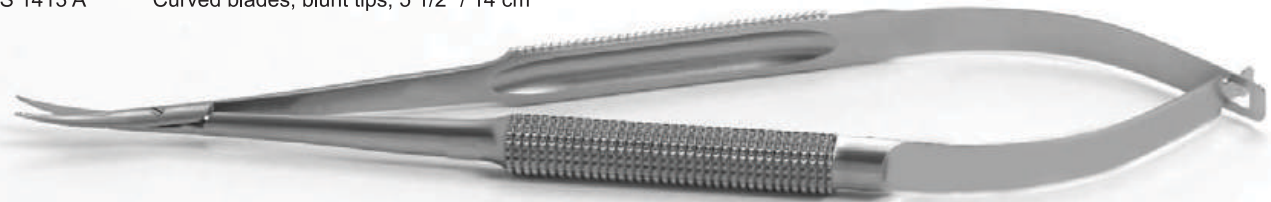

Castroviejo Micro Scissors, Round Handle

Cat. No.	Description
CS 1414	Straight blades, sharp tips, 7" / 18 cm
CS 1415	Curved blades, sharp tips, 7" / 18 cm
CS 1415 A	Curved blades, blunt tips, 7" / 18 cm

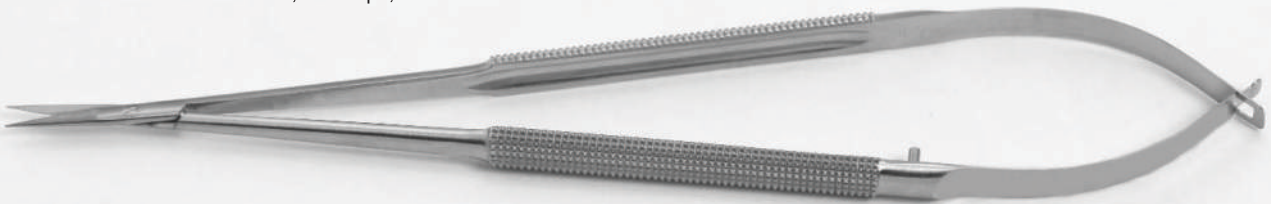

Micro Scissors, Round Handle

Cat. No.	Description
CS 1416 A	25° angled blades, 4 1/2" / 11.5 cm
CS 1416 B	45° angled blades, 4 1/2" / 11.5 cm
CS 1416 C	60° angled blades, 4 1/2" / 11.5 cm
CS 1416 D	90° angled blades, 4 1/4" / 11 cm
CS 1416 E	125° angled blades, 4 1/4" / 11 cm

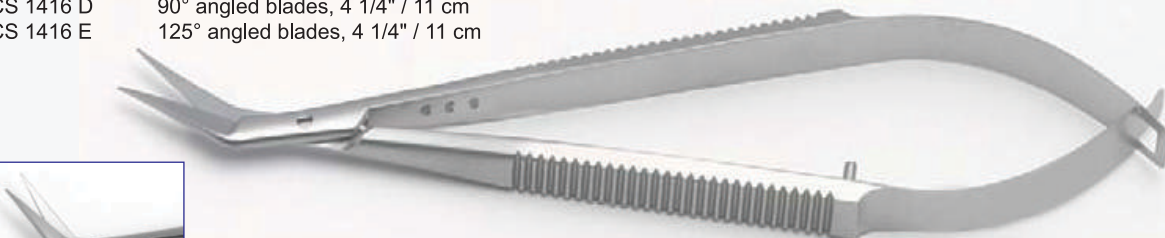

Castroviejo Micro Scissors, Flat Handle, Angled Fine Blades



Surgitech

CLASSIC, EXCLUSIVE & ELEGANCE STYLE SURGICAL INSTRUMENTS

SPRING STYLE
SCISSORS

Cat. No.	Description
CS 1417 A	25° angled blades, 4 1/4" / 11 cm
CS 1417 B	45° angled blades, 4 1/4" / 11 cm
CS 1418 C	60° angled blades, 4 1/8" / 10.5 cm
CS 1419 D	90° angled blades, 4 1/8" / 10.5 cm
CS 1418 E	125° angled blades, 4 1/8" / 10.5 cm

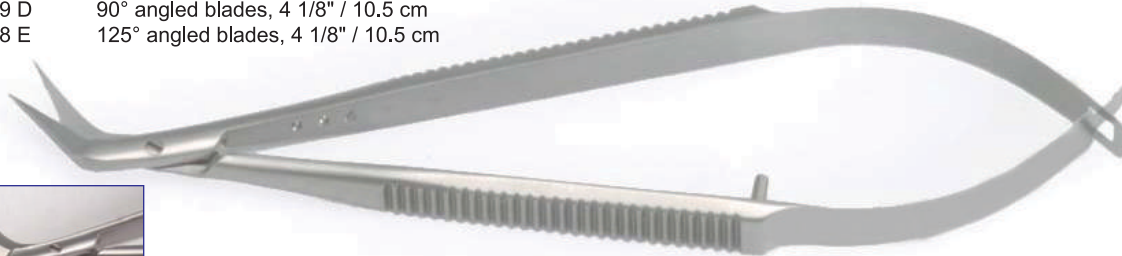

Castroveijo Micro Scissors, Flat Handle, Angled Micro Fine Blades

Cat. No.	Description
CS 1420 A	25° angled blades, 6 1/4" / 16 cm
CS 1420 B	45° angled blades, 6 1/4" / 16 cm
CS 1420 C	60° angled blades, 6 1/4" / 16 cm
CS 1421 D	90° angled blades, 6 1/8" / 15.5 cm
CS 1421 E	V-neck, 125° angled blades, 6 1/8" / 15.5 cm



Micro Scissors, Flat Handle, Angled Nano Blades

Cat. No.	Description
CS 1422 A	25° angled blades, 6 1/2" / 16.5 cm
CS 1422 B	45° angled blades, 6 1/2" / 16.5 cm
CS 1422 C	60° angled blades, 6 1/2" / 16.5 cm
CS 1423 D	90° angled blades, 6 1/4" / 16 cm
CS 1424 E	125° angled blades, 6 1/4" / 16 cm

Jacobson Micro Scissors, Flat Handle,
Angled Micro Fine Blades

Cat. No.	Description
CS 1425 E	6 1/4" / 16 cm
CS 1426 E	8" / 18 cm



Micro Scissors, Flat Handle, V-neck,
125° Angled Micro Fine Blades

Cat. No.	Description
CS 1427 A	25° angled blades, sharp tips, 6 1/2" / 16.5 cm
CS 1427 B	45° angled blades, sharp tips, 6 1/2" / 16.5 cm
CS 1427 BA	45° angled blades, blunt tips, 6 1/2" / 16.5 cm
CS 1427 C	60° angled blades, sharp tips, 6 1/2" / 16.5 cm
CS 1427 D	90° angled blades, sharp tips, 6 1/4" / 16 cm
CS 1427 E	125° angled blades, sharp tips, 6 1/4" / 16 cm

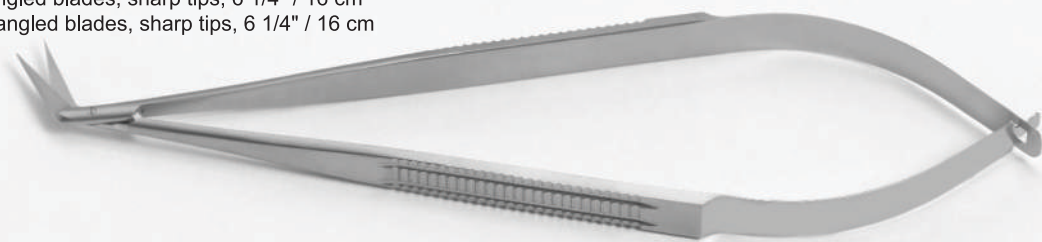

Micro Scissors, Flat Handle, Angled Fine Blades



Surgitech

CLASSIC, EXCLUSIVE & ELEGANCE STYLE SURGICAL INSTRUMENTS

SPRING STYLE
SCISSORS

Cat. No.	Description
CS 1428 A	25° angled blades, 6 1/2" / 16.5 cm
CS 1428 B	45° angled blades, 6 1/2" / 16.5 cm
CS 1428 C	60° angled blades, 6 1/2" / 16.5 cm
CS 1429 D	90° angled blades, 6 1/4" / 16 cm
CS 1429 E	125° angled blades, 6 1/4" / 16 cm

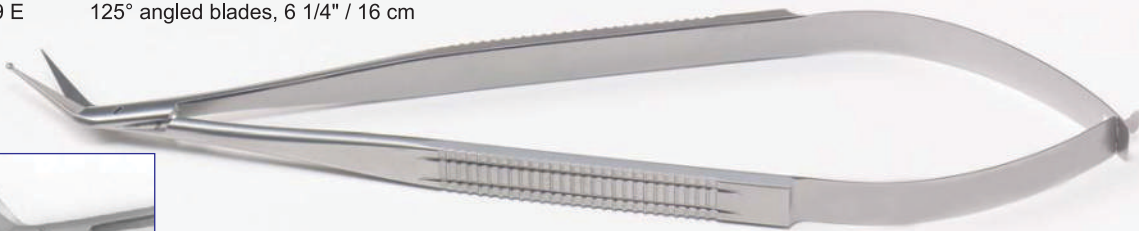

Micro Scissors, Flat Handle, One Blade with Bead Tip

Cat. No.	Description
CS 1430 D	LIMA, left 90° angled fine blades, 8" / 20 cm



Micro Scissors, 45° Angled Up

Cat. No.	Description
CS 1431 D	RIMA, right 90° angled fine blades, 8" / 20 cm



Cat. No.	Description
CS 1432 B	45° angled nano blades, 8" / 20 cm
CS 1433 B	Reversed handle, angled left, 45° angled nano blades, 8" / 20 cm
CS 1434 E	Angled left, V-neck, 125° angled nano blades, 8" / 20 cm
CS 1435 E	Angled right, V-neck, 125° angled nano blades, 8" / 20 cm



Micro Scissors, Flat Handle, Bayonet Style



Surgitech

CLASSIC, EXCLUSIVE & ELEGANCE STYLE SURGICAL INSTRUMENTS

SPRING STYLE
SCISSORS



Micro Scissors, Flat Handle, Bayonet Style

Cat. No.	Description
CS 1436 E	5 1/2" / 14 cm
CS 1437 E	7 1/8" / 18.1 cm



Micro Circumflex Scissors, Flat Handle, 125° Angled Fine Blades, Bayonet-Style

Cat. No.	Description
CS 1438 A	25° angled blades, 7" / 18 cm

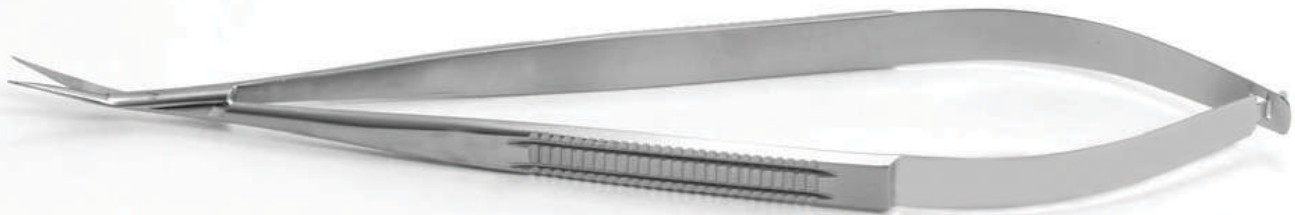

Micro Scissors, Flat Handle, Angled on Flat Fine Blades

Cat. No.	Description
CS 1439 B	7" / 18 cm

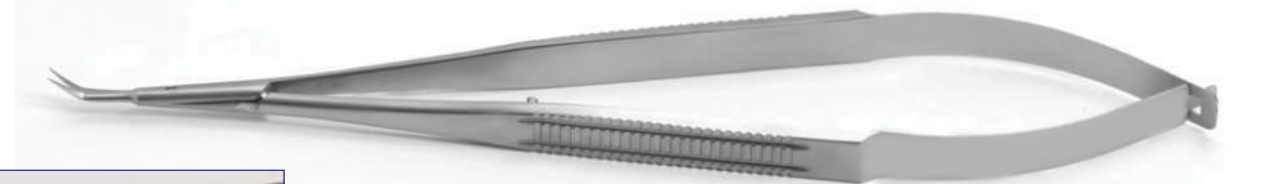

Vannas Micro Scissors, Flat Handle, 45° Angled on Flat Micro Fine Blades



Surgitech

CLASSIC, EXCLUSIVE & ELEGANCE STYLE SURGICAL INSTRUMENTS

SPRING STYLE
SCISSORS

Cat. No.	Description
CS 1440	Straight blades, sharp tips, 5 1/2" / 14 cm
CS 1440 A	Curved blades, sharp tips, 5 1/2" / 14 cm

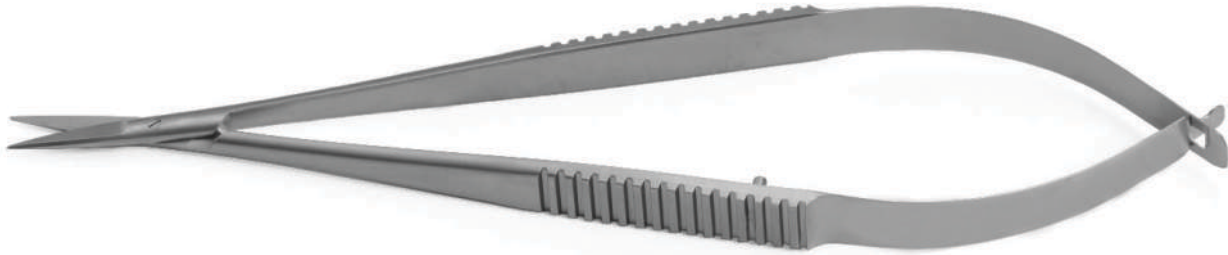

Castroviejo Micro Scissors, Flat Handle

Cat. No.	Description
CS 1441	Straight blades, sharp tips, 7" / 18 cm
CS 1442	Curved blades, sharp tips, 7" / 18 cm
CS 1442 A	Curved blades, blunt tips, 7" / 18 cm

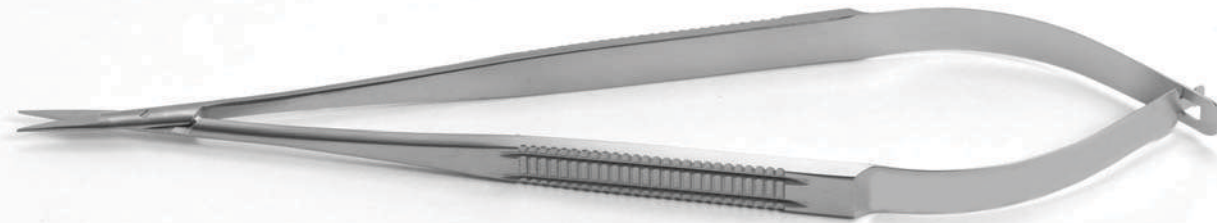

Micro Scissors, Flat Handle

DYNACUT	DUROEDGE	Description
CS 1443 UA	CS 1443 A	25° angled fine blades
CS 1444 UA	CS 1444 A	25° angled micro fine blades
CS 1443 UB	CS 1443 B	45° angled fine blades
CS 1444 UB	CS 1444 B	45° angled micro fine blades
CS 1443 UC	CS 1443 C	60° angled fine blades
CS 1444 UC	CS 1444 C	60° angled micro fine blades
CS 1443 UD	CS 1443 D	90° angled fine blades
CS 1444 UD	CS 1444 D	90° angled micro fine blades
CS 1443 UE	CS 1443 E	125° angled fine blades
CS 1444 UE	CS 1444 E	125° angled micro fine blades

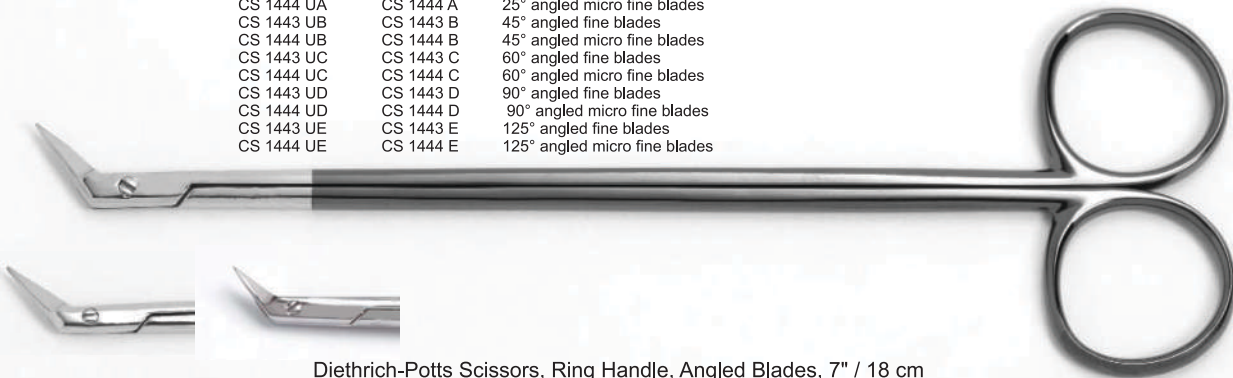

Diethrich-Potts Scissors, Ring Handle, Angled Blades, 7" / 18 cm

Cat. No.	Description	Cat. No.	Description
CS 1445 A	25° angled fine blades	CS 1446 C	60° angled micro fine blades
CS 1446 A	25° angled micro fine blades	CS 1445 D	90° angled fine blades
CS 1445 B	45° angled fine blades	CS 1446 D	90° angled micro fine blades
CS 1446 B	45° angled micro fine blades	CS 1445 E	Fine blades
CS 1445 C	60° angled fine blades	CS 1446 E	Micro fine blades



Diethrich-Potts Scissors, Ring Handle, 125° Angled Blades, 6 3/4" / 17 cm



Surgitech

CLASSIC, EXCLUSIVE & ELEGANCE STYLE SURGICAL INSTRUMENTS

SCISSORS

DYNACUT	DUROEDGE	Description
CS 1447 UE	CS 1447 E	Fine blades
CS 1448 UE	CS 1448 E	Micro fine blades



Favaloro Scissors, Ring Handle, 125° Angled Blades, 6 3/4" / 17 cm

Cat. No.	Description
CS 1449 A	25° angled blades
CS 1449 B	45° angled blades
CS 1449 C	60° angled blades
CS 1449 D	90° angled blades



Hegeman Scissors, Ring Handle, 5 1/2" / 14 cm

Cat. No.	Description
CS 1450 A	25° angled blades, blunt tips, 6 3/4" / 17 cm
CS 1451 B	45° angled blades, sharp tips, 6 1/4" / 16 cm
CS 1450 B	45° angled blades, blunt tips, 6 1/4" / 16 cm
CS 1451 C	60° angled blades, sharp tips, 6 1/4" / 16 cm
CS 1450 C	60° angled blades, blunt tips, 6 1/4" / 16 cm



DeBakey Scissors, Ring Handle, 45° Angled Blades, Blunt Tips
DeBakey Scissors, Ring Handle

Cat. No.	Description
CS 1452	Curved blades, Sharp tips, 7 1/8" / 18.1 cm
CS 1452 A	Tenotomy tips, 7 1/8" / 18.1 cm

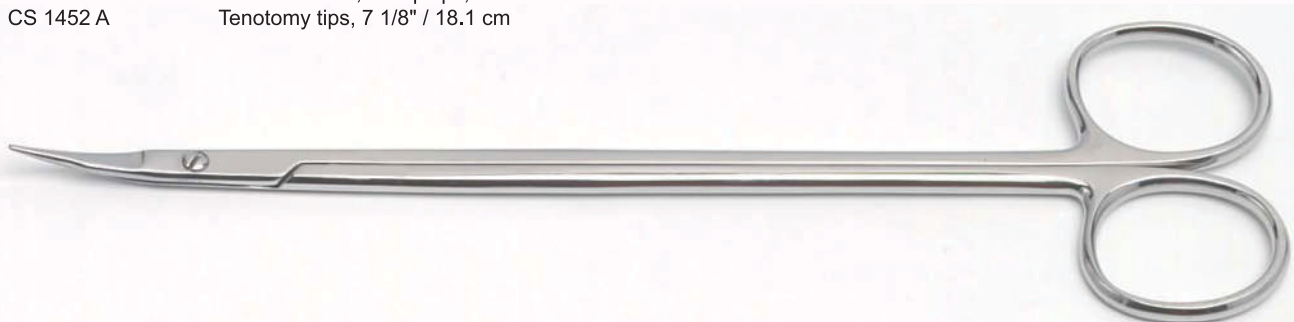

Laine-Kindal Scissors, Ring Handle, Curved Blades



Surgitech

CLASSIC, EXCLUSIVE & ELEGANCE STYLE SURGICAL INSTRUMENTS

DYNACUT	DUROEDGE	Description
CS 1453 U	CS 1453	Straight blades, sharp tips, 4" / 10 cm
CS 1453 UA	CS 1453 A	Straight blades, blunt tips, 4" / 10 cm
CS 1454 U	CS 1454	Curved blades, sharp tips, 4" / 10 cm
CS 1454 UA	CS 1454 A	Curved blades, blunt tips, 4" / 10 cm

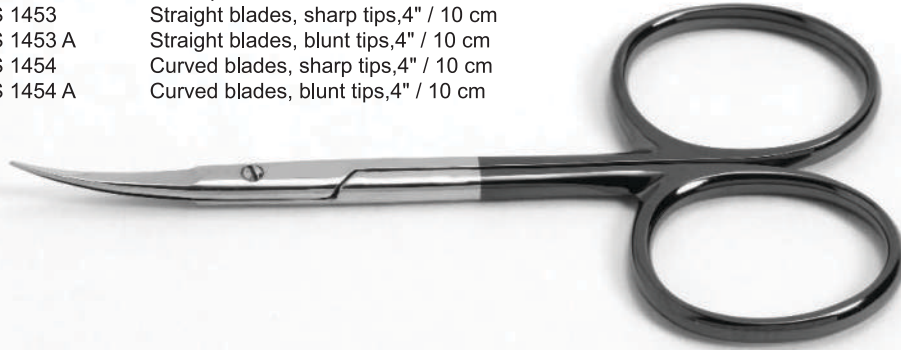

Iris-Eye Scissors, Ring Handle

DYNACUT	DUROEDGE	Description
CS 1455 U	CS 1455	Straight blades, 4 3/4" / 12 cm
CS 1455 UA	CS 1455 A	Curved blades, 4 3/4" / 12 cm



Plastic-Jabaley Scissors, Ring Handle

Cat. No.	Description
CS 1456	Blunt tips, 5 5/8" / 14.1 cm
CS 1456 A	Tenotomy tips, 5 1/2" / 14 cm



Dissecting Scissors, Ring Handle, Curved Blades

DYNACUT	DUROEDGE	Description
CS 1457 U		4 3/4" / 12 cm
CS 1458 U		6" / 15 cm
CS 1459 U	CS 1459	7" / 18 cm
CS 1460 U		8" / 20 cm
CS 1461 U	CS 1461	9" / 23 cm
CS 1462 U		10 1/4" / 26 cm



Ragnell Dissecting Scissors, Ring Handle, Curved Blades, Flat Tips



Surgitech

CLASSIC, EXCLUSIVE & ELEGANCE STYLE SURGICAL INSTRUMENTS

SCISSORS

DYNACUT	DUROEDGE	Description
CS 1463 U		Straight blades, 4 5/8" / 11.5 cm
CS 1464 U	CS 1464	Curved blades, 4 5/8" / 11.5 cm
CS 1465 U	CS 1465	Curved blades, 6" / 15 cm
CS 1466 U	CS 1466	Curved blades, 7" / 18 cm
CS 1467 U	CS 1467	Curved blades, 8" / 20 cm



Stevens Tenotomy Scissors, Ring Handle

DYNACUT	DUROEDGE	Description
CS 1468 U		Curved blades, 6 1/2" / 16.5 cm
CS 1469 U	CS 1469	Curved blades, 7" / 18 cm
CS 1470 U		Curved blades, 9" / 23 cm



Lillehei-Potts Scissors, Ring Handle, Tenotomy Tips

Cat. No.	Description
CS 1471	5 1/2" / 14 cm



Scissors, Ring Handle, Curved Blades, Tenotomy Tips

DYNACUT	DUROEDGE	Description
CS 1472 U	CS 1472	Straight blades, 6" / 15 cm
CS 1473 U	CS 1473	Curved blades, 6" / 15 cm
CS 1474 U	CS 1474	Curved blades, 7" / 18 cm
CS 1475 U		Curved blades, 8" / 20 cm
CS 1476 U		Curved blades, 9" / 23 cm
CS 1477 U	CS 1478	Straight blades, 10 1/4" / 26 cm
CS 1478 U		Curved blades, 10 1/4" / 26 cm



Metzenbaum Scissors, Ring Handle, Tenotomy Tips



Surgitech

CLASSIC, EXCLUSIVE & ELEGANCE STYLE SURGICAL INSTRUMENTS

SCISSORS

Cat. No.	Description
CS 1479	7 1/8" / 18.1 cm



Laine-Kindal Scissors, Ring Handle, Curved Blades, Tenotomy Tips

DYNACUT	DUROEDGE	Description
CS 1480 U		"Black Knight", Sharp Tips, 6 1/2" / 16.5 cm
CS 1481 U		Tenotomy Tips, 6 1/2" / 16.5 cm
CS 1482 U		Sharp tips, 7" / 18 cm
CS 1483 U	CS 1483	Blunt tips, 7" / 18 cm
CS 1484 U	CS 1484	Tenotomy tips, 7" / 18 cm
CS 1485 U		Sharp tips, 9" / 23 cm
CS 1486 U	CS 1486	Blunt tips, 9" / 23 cm
CS 1487 U		Tenotomy tips, 9" / 23 cm



Lillehei-Potts Scissors, Ring Handle, Curved Blades

Cat. No.	Description
CS 1488	Straight blades, sharp tips
CS 1488 A	Straight blades, tenotomy tips
CS 1489	Curved blades, sharp tips
CS 1489 A	Curved blades, blunt tips
CS 1489 B	Curved blades, tenotomy tips



Lillehei-Potts Scissors, Ring Handle, 7" / 18 cm

DYNACUT	DUROEDGE	Description
CS 1490 U		Straight blades, 6" / 15 cm
CS 1490 UA	CS 1490 A	Curved blades, 6" / 15 cm

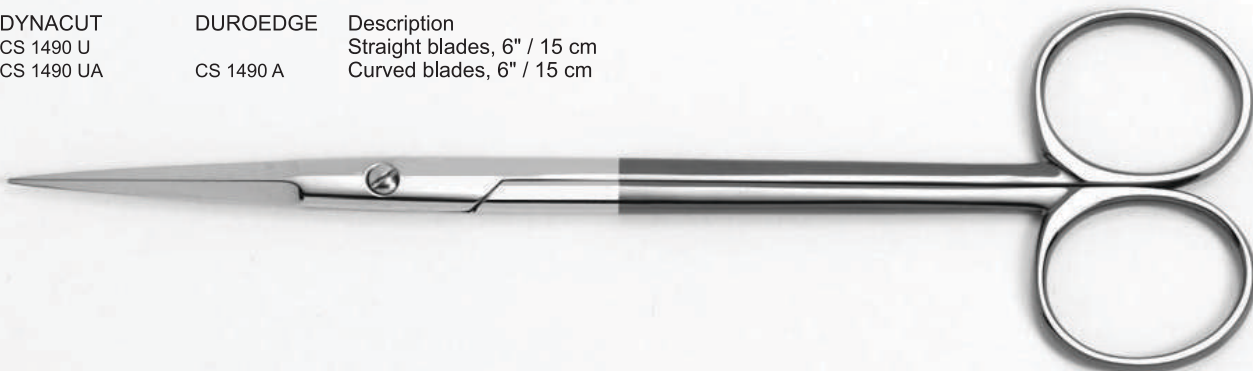

C.V.H. Scissors, Ring Handle, Sharp Tips, 6" / 15 cm



Surgitech

CLASSIC, EXCLUSIVE & ELEGANCE STYLE SURGICAL INSTRUMENTS

DYNACUT	DUROEDGE	Description
CS 1491 U		Straight blades, 8" / 20 cm
CS 1492 U	CS 1492	Curved blades, 8" / 20 cm
CS 1493 U	CS 1493	Curved blades, 9" / 23 cm
CS 1494 U	CS 1494	Curved blades, 12" / 30.5 cm



Mayo Harrington Scissors, Ring Handle

Cat. No.	Description
CS 1495	Extra light, 7" / 18 cm



Metzbaum Scissors, Ring Handle, Curved Blades

DYNACUT	DUROEDGE	Description	DYNACUT	DUROEDGE	Description
CS 1496 U		Curved blades, baby, 4 3/4" / 12 cm	CS 14106 U	CS 14106	Curved blades, fine tips, 9" / 23 cm
CS 1497 U		Straight blades, tenotomy tips, 6" / 15 cm	CS 14107 U		Curved blades, tenotomy tips, 9" / 23 cm
CS 1498 U	CS 1498	Curved blades, 6" / 15 cm	CS 14108 U		Straight blades, tenotomy tips, 10 1/4" / 26 cm
CS 1499 U	CS 1499	Curved blades, fine tips, 6" / 15 cm	CS 14109 U	CS 14109	Curved blades, 10 1/4" / 26 cm
CS 14100 U	CS 14100	Curved blades, tenotomy tips, 6" / 15 cm			
CS 14101 U		Straight blades, 7" / 18 cm			
CS 14102 U	CS 14102	Curved blades, 7" / 18 cm			
CS 14103 U	CS 14103	Curved blades, fine tips, 7" / 18 cm			
CS 14104 U	CS 14104	Curved blades, tenotomy tips, 7" / 18 cm			
CS 14105 U		Curved blades, 2.5 mm blunt tips, 7" / 18 cm			



DYNACUT	DUROEDGE	Description	DYNACUT	DUROEDGE	Description
CS 14110 U		Curved blades, left-handed, 7" / 18 cm	CS 14117 U		Curved blades, fine tips, 10 1/4" / 26 cm
CS 14111 U		Straight blades, 8" / 20 cm	CS 14118 U		Curved blades, tenotomy tips, 10 1/4" / 26 cm
CS 14112 U	CS 14112	Curved blades, 8" / 20 cm	CS 14119 U		Curved blades, 12" / 30.5 cm
CS 14113 U	CS 14113	Curved blades, fine tips, 8" / 20 cm	CS 14120 U		Curved blades, fine tips, 12" / 30.5 cm
CS 14114 U		Curved blades, tenotomy tips 8" / 20 cm			
CS 14115 U		Straight blades, 9" / 23 cm			
CS 14116 U	CS 14116	Curved blades, 9" / 23 cm			

Metzbaum Scissors, Ring Handle, Curved Blades

DYNACUT	DUROEDGE	Description
CS 14121 U	CS 14121	Straight round blades, 6 3/4" / 17 cm
CS 14122 U	CS 14122	Straight round blades, 7 1/2" / 19 cm
CS 14123 U	CS 14123	Curved round blades, 6 3/4" / 17 cm
CS 14124 U		Curved round blades, 7 1/2" / 19 cm



Mayo Scissors, Ring Handle



Surgitech

CLASSIC, EXCLUSIVE & ELEGANCE STYLE SURGICAL INSTRUMENTS

SCISSORS

Cat. No.	Description
CS 14125	Round blades, 6 3/4" / 17 cm
CS 14126	Round blades, 10" / 25 cm



Mayo Scissors, Ring Handle, Full Curved Blades

Cat. No.	Description
CS 14127	Curved blades, 6 1/2" / 16.5 cm
CS 14128	Straight blades, 7 3/4" / 19.5 cm
CS 14128 A	Curved blades, 7 3/4" / 19.5 cm



Face-Lift Scissors, Ring Handle, Semi-Sharp Outer Blade

Cat. No.	Description
CS 14129	8 1/2" / 21.5 cm
CS 14130	9 7/8" / 25 cm



Thompson Valve Scissors, Ring Handle, Full Curved (One Serrated) Blades

Cat. No.	Description
CS 14131	12" / 30.5 cm



Flemma Mitral Repair Scissors, Ring Handle, Curved Blades, Flat Tips



Surgitech

CLASSIC, EXCLUSIVE & ELEGANCE STYLE SURGICAL INSTRUMENTS

DISSECTORS / HOOKS / PROBES

Cat. No.	Description
CS 1511	1 mm and 2 mm, 7 1/8" / 18 cm
CS 1512	3 mm and 4 mm, 7 1/8" 18.1 cm



Ochsner Double-Ended Dissectors

Cat. No.	Description
CS 1513	7 1/2" / 19 cm



Ochsner Angled Delicate Plane Finder Dissector, Angled with Ball

Cat. No.	Description
CS 1514	Curved fine tips, 6 1/8" / 15.5 cm
CS 1515	Straight fine tips, 6 1/8" / 15.5 cm



Ochsner Plaque Remover, Ring Handle

Cat. No.	Description
CS 1516	Small, 7 1/4" / 18.5 cm



Krayenbuhl Micro Nerve and Vessel Hooks

Cat. No.	Description
CS 1517	Large, 7 1/4" / 18.5 cm



Krayenbuhl Probes



Surgitech

CLASSIC, EXCLUSIVE & ELEGANCE STYLE SURGICAL INSTRUMENTS

TUBE PASSER /
HOOKS

Cat. No.	Description
CS 1518	Without ratchet, 9 3/4" / 24.2 cm
CS 1519	With ratchet, 9 3/4" / 24.2 cm
CS 1520	Without ratchet, 14" / 35.6 cm

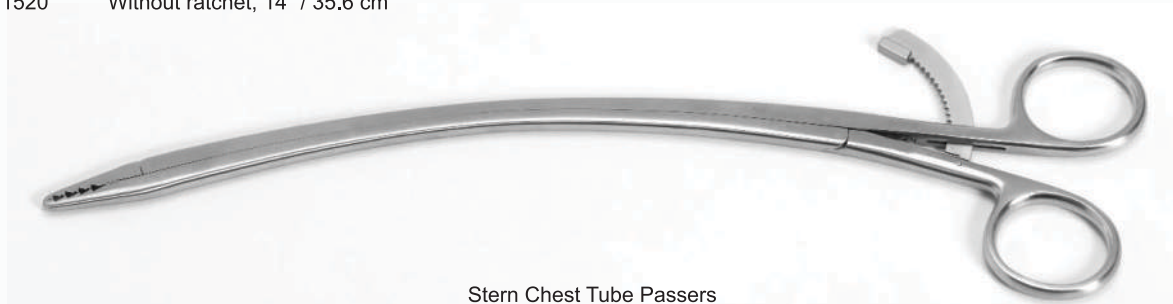

Stern Chest Tube Passers

Cat. No.	Description
CS 1521	Right short, 4 1/4" / 11.5 cm



Phlebectomy Hooks, Black Platinum Handle

Cat. No.	Description
CS 1522	Left short, 4 1/4" / 11.5 cm



Phlebectomy Hooks, Black Platinum Handle

Cat. No.	Description
CS 1523	Right long, 5 1/2" / 14 cm



Phlebectomy Hooks, Black Platinum Handle



Surgitech

CLASSIC, EXCLUSIVE & ELEGANCE STYLE SURGICAL INSTRUMENTS

RETRACTORS /
HOOKS

Cat. No.	Description
CS 1601	3/4" / 19 mm wide, 6 1/2" / 16.5 cm long
CS 1602	5/8" / 15.6 mm wide, 6 1/2" / 16.5 cm long
CS 1603	1/2" / 12.7 mm wide, 6 1/2" / 16.5 cm long
CS 1604	3/8" / 9.5 mm wide, 6 1/2" / 16.5 cm long
CS 1605	1/4" / 6.4 mm wide, 6 1/2" / 16.5 cm long



Cochran Pediatric Retractors

Cat. No.	Description
CS 1606	Two semi-sharp points, 10 3/4" / 27.3 cm
CS 1607	One semi-sharp point, 10 3/4" / 27.3 cm



Bryant Mitral Hooks



Bryant Mitral Hooks



Bryant Mitral Hooks



Bryant Mitral Hooks



Pediatric Retractor

Cat. No.
CS 1608

Description
Titanium Retractor with Interchangeable Blades, 52 mm spread; includes two pair of blades: one pair 10 mm long x 15 mm deep, one pair 20 mm long x 15 mm deep; two arms: each 40 mm long



Pediatric Finochietto Retractors

Cat. No.
CS 1609

Description
Bailey Finochietto Sternal Retractor, titanium, 80 mm spread; includes two blades: each 20 mm long x 20 mm deep; two arms: each 57 mm long

CS 1610

Bailey Finochietto Retractor, aluminum, 80 mm spread; includes two blades: each 15 mm long x 15 mm deep; two arms: each 56 mm long



Surgitech

CLASSIC, EXCLUSIVE & ELEGANCE STYLE SURGICAL INSTRUMENTS

RETRACTORS

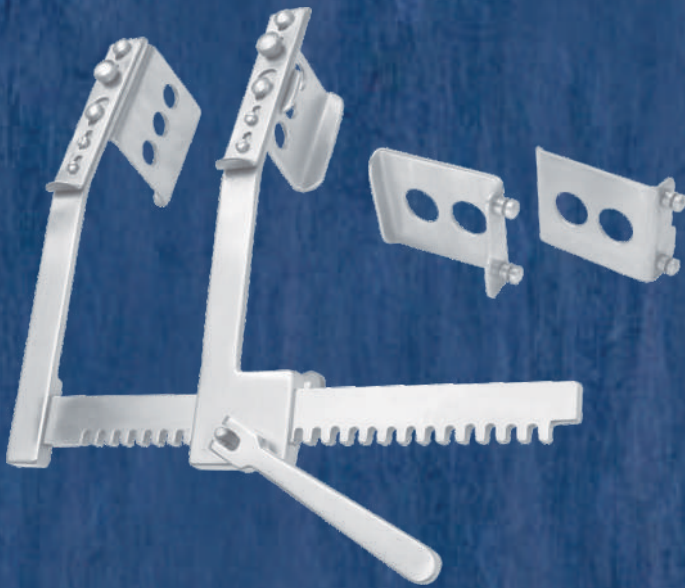

Finochitto Chest Retractor/Spreader

- CS 1611 A - Neonatal
- CS 1611 B - Infant
- CS 1611 C - Child
- CS 1611D - Small Adult
- CS 1611E - Medium Adult
- CS 1611F - Large Adult



Morse Self Retaining 4 Blade Sternal Spreader

- CS 1612A - Neonatal
- CS1612B - Infant
- CS1612C - Child
- CS1612D - Small Adult
- CS1612E - Medium Adult
- CS1612F - Large Adult



Morse Self Retaining 4 Blade Sternal Spreader Modified for Stabiliser

- CS1613A - Neonatal
- CS1613B - Infant
- CS1613C - Child
- CS1613D - Small Adult
- CS1613E - Medium Adult
- CS1613F - Large Adult

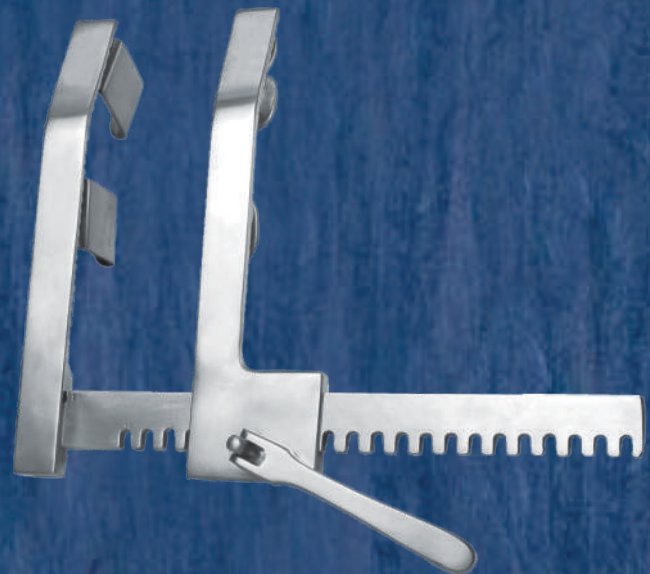

Finochitto Chest Retractor Burford with Interchangeable Blades

- CS 1614A - Neonatal
- CS 1614B - Infant
- CS 1614C - Child
- CS 1614D - Small Adult
- CS 1614E - Medium Adult
- CS 1614F - Large Adult



Surgitech

CLASSIC, EXCLUSIVE & ELEGANCE STYLE SURGICAL INSTRUMENTS

RETRACTORS /
BAILEY



Cooley Retractor

- CS 1615A - Neonatal
- CS 1615B - Infant
- CS 1615C - Child
- CS 1615D - Small Adult
- CS 1615E - Medium Adult
- CS 1615F - Large Adult

Carpentier Retractor

- CS 1616A - Neonatal
- CS 1616B - Infant
- CS 1616C - Child
- CS 1616D - Small Adult
- CS 1616E - Medium Adult
- CS 1616F - Large Adult



CS 1617
Rib Approximator Bailey



CS 1618
Rib Approximator Bailey
with Rotatable Jaws



CS 1619
Allison Lung Retractor



Surgitech

CLASSIC, EXCLUSIVE & ELEGANCE STYLE SURGICAL INSTRUMENTS

DIADUST MICRO
RING FORCEPS TC



CS 1130
145mm
5 3/4"



CS 1131
160mm
6 1/4"



CS 1132
185mm
7 1/4"



CS 1133
210mm
8 1/4"



CS 1134
220mm
9"

Ring Tips Forceps D-Dust Tungsten Carbide Tips Round Handle & Counter Balanced



Surgitech

CLASSIC, EXCLUSIVE & ELEGANCE STYLE SURGICAL INSTRUMENTS

DIADUST MICRO
FORCEPS TC



CS 1298
145mm
5 3/4"



CS 1299
60mm
6 1/4"



CS 12100
185mm
7 1/4"



CS 12101
210mm
8 1/4"



CS 12102
220mm
9"

Fine Tips Forceps D-Dust Tungsten Carbide Tips Flat Handle



Surgitech

CLASSIC, EXCLUSIVE & ELEGANCE STYLE SURGICAL INSTRUMENTS

DIADUST CASTROVIEJO
NEEDLE HOLDER TC

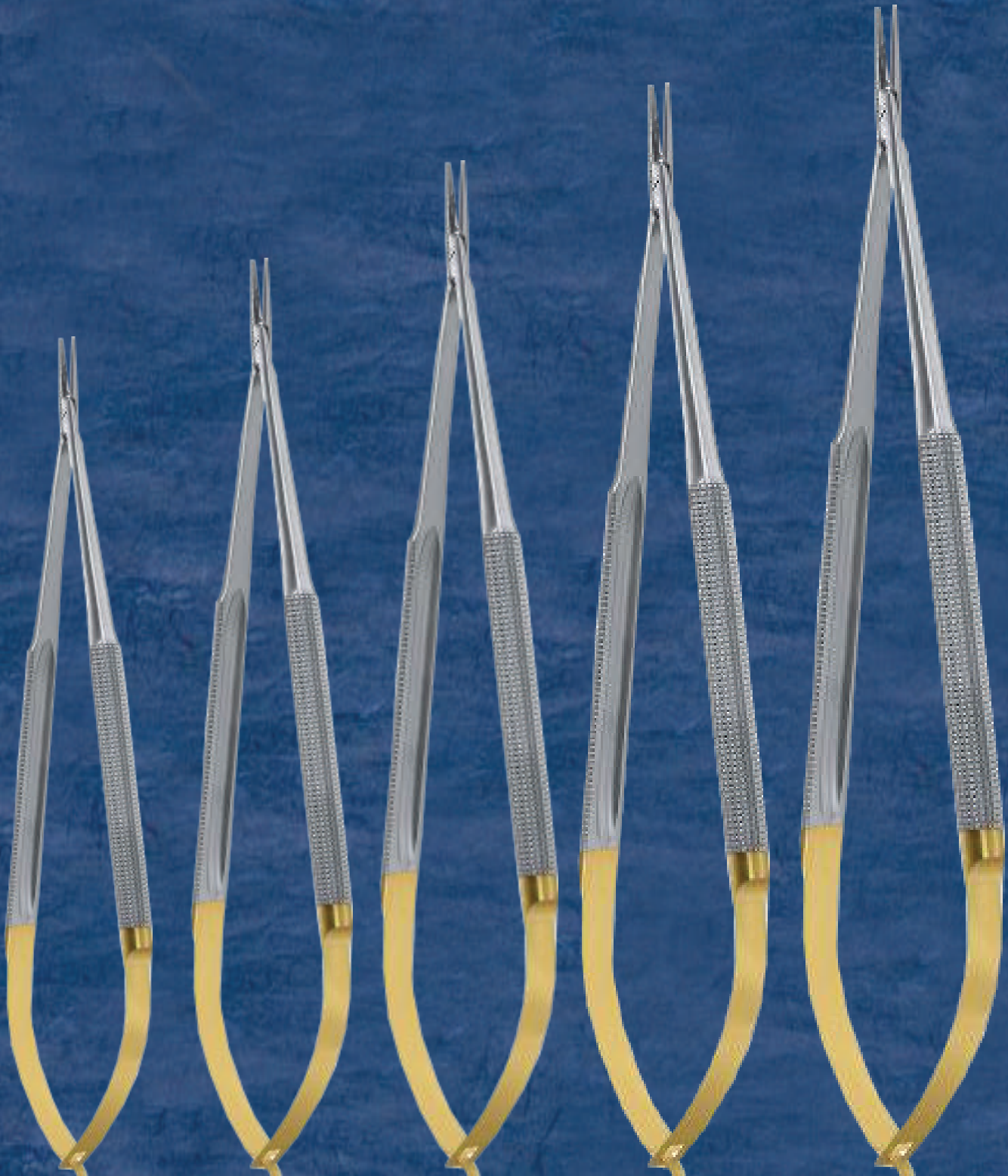

CS 10107
145mm
5 3/4"

CS 10108
160mm
6 1/4"

CS 10109
185mm
7 1/4"

CS 10110
210mm
8 1/4"

CS 10111
220mm
9"

Castro Viejo Needle Holder with D-Dust Tungsten Carbide Tips Round Handle



Surgitech

CLASSIC, EXCLUSIVE & ELEGANCE STYLE SURGICAL INSTRUMENTS

**CASTRO VIEJO DIADUST
NEEDLE HOLDER TC**



CS 10112
230mm
9"

CS 10113
250mm
10"

Castro Viejo Needle Holder D-Dust Tips with Round Handle



Surgitech

CLASSIC, EXCLUSIVE & ELEGANCE STYLE SURGICAL INSTRUMENTS

CASTRO VIEJO DIADUST
NEEDLE HOLDER TC



CS 10114
230mm
9"



CS 10115
210mm
8¼"



CS 10116
185mm
7¼"



CS 10117
170mm
6¾"



CS 10118
145mm
5¾"

Castro Viejo Needle Holder D-Dust Tips with Flat Handle



Surgitech

CLASSIC, EXCLUSIVE & ELEGANCE STYLE SURGICAL INSTRUMENTS

SPECIAL NEEDLE
HOLDER TC



GLASSER SUTURE SIZE : 5/0 AND SMALLER

CS 10119 - 125 MM, 5"

CS 10120 - 180 MM, 7"

RYDER NEEDLE HOLDER WITH RING HANDLES

CS 10121 - 144 MM, 5½"

CS 10122 - 160 MM, 6¼"

CS 10123 - 180 MM, 7"

CS 10124 - 220 MM, 8¾"

CS 10125 - 250 MM, 10"

Needle Holder with D-Dust Tips



Surgitech

CLASSIC, EXCLUSIVE & ELEGANCE STYLE SURGICAL INSTRUMENTS

SHUNT OPERATION
INSTRUMENTS



MICRO NEEDLE HOLDER
CS 10126 - 180 MM, 7"



MICRO DISSECTING FORCEPS
CS 12103 - 180 MM, 7"



MICRO TISSUE FORCEPS
CS 12104 - 180 MM, 7"

Micro Needle Holder with Round and Flat Handles



Surgitech

CLASSIC, EXCLUSIVE & ELEGANCE STYLE SURGICAL INSTRUMENTS

**DIADUST MICRO
RING FORCEPS TC**

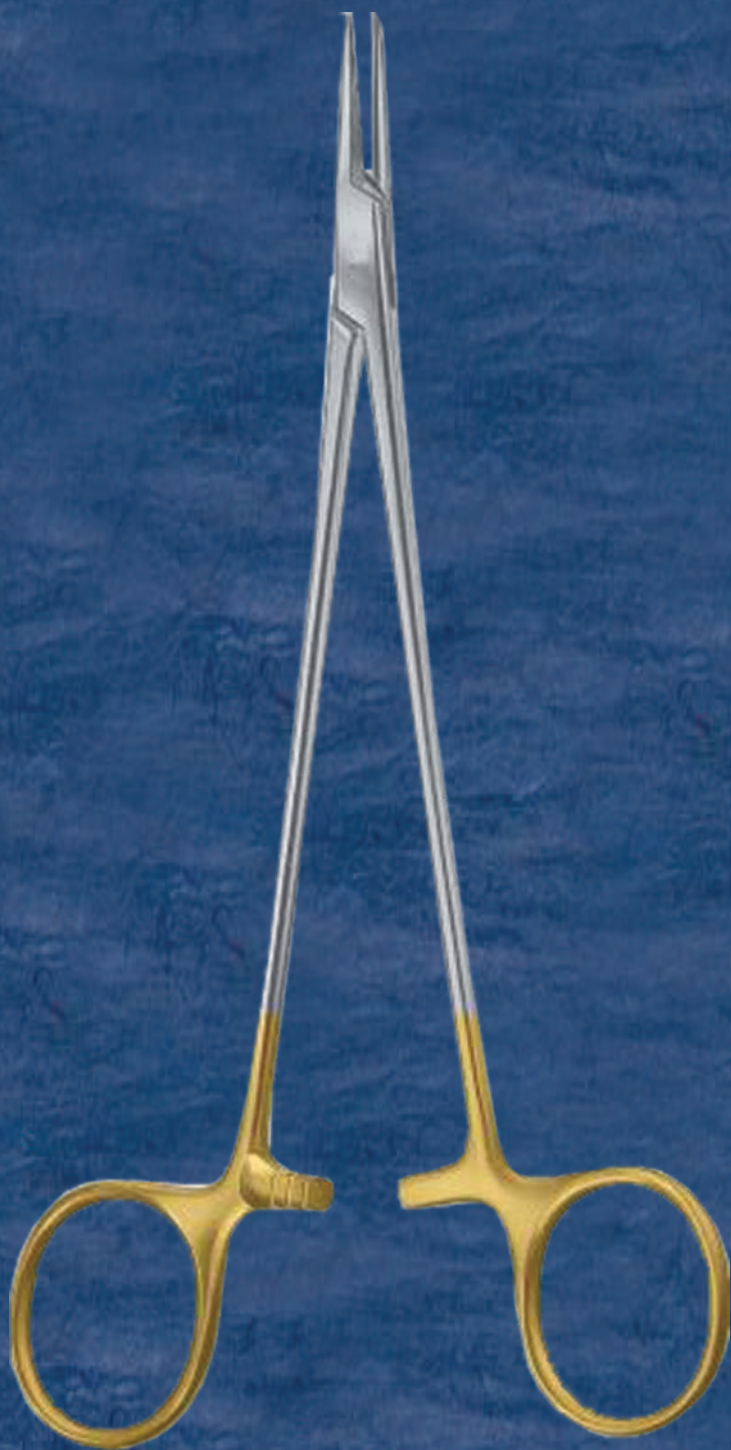

RYDER STYLE DE BAKEY TIPS
CS 10130 - 0.4 MM - 165 MM, 6½”
CS 10131 - 0.4 MM - 210 MM, 8¼”

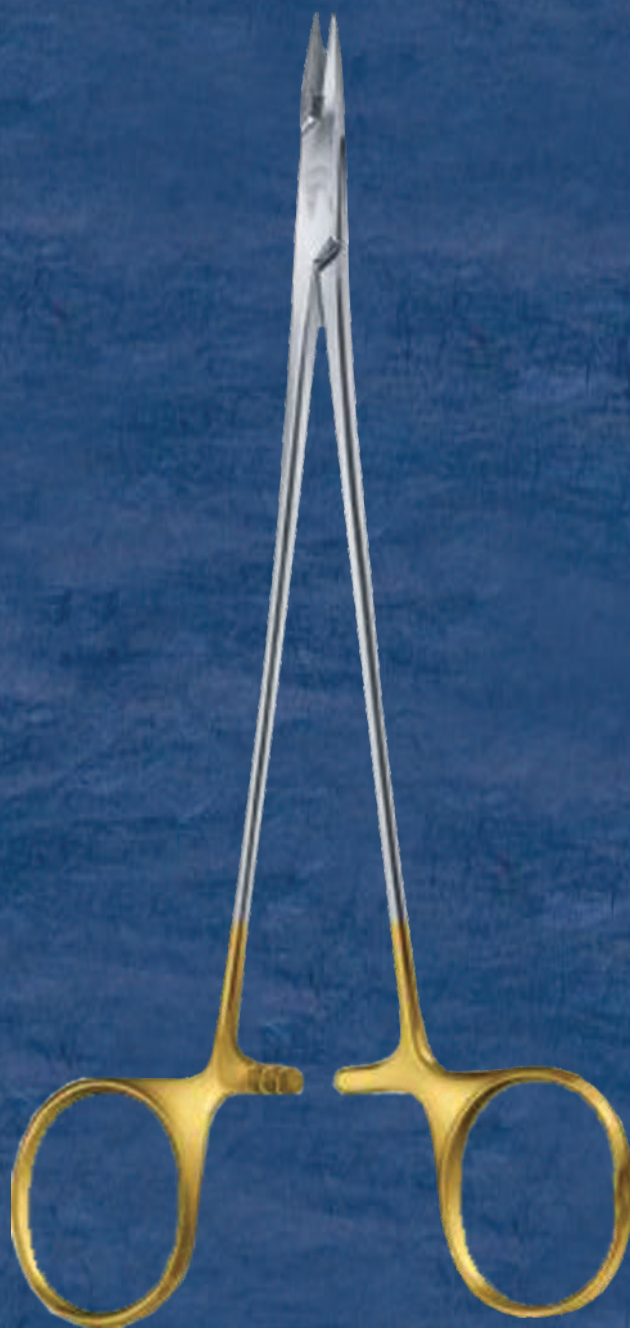

RYDER STYLE DE-BAKEY TIPS
CS 10132 - 0.2 MM - 165 MM, 6½”
CS 10133 - 0.2 MM - 210 MM, 8¼”

Very Delicate Micro Needle Holder With Tc Tips



Surgitech

CLASSIC, EXCLUSIVE & ELEGANCE STYLE SURGICAL INSTRUMENTS

DIADUST MICRO
RING FORCEPS TC



RYDER STYLE TC TIPS
CS 10134 - 200 MM - 8"

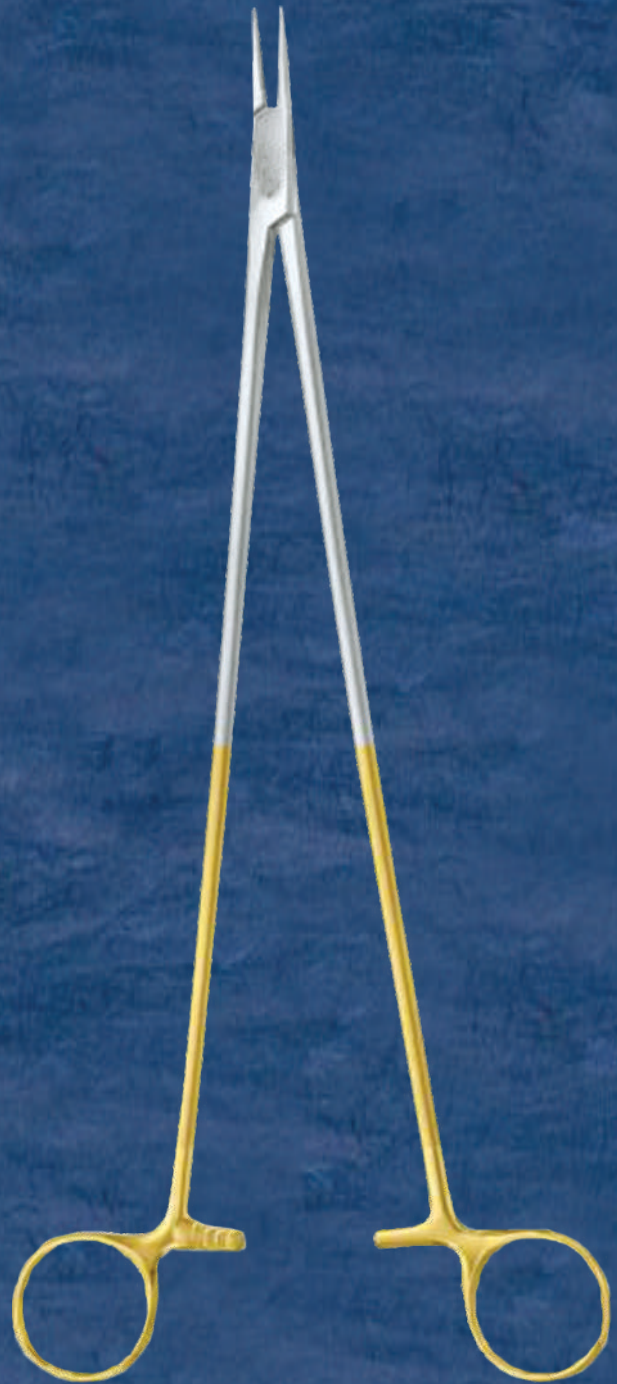

TC STYLE DE BAKKEY TIPS
SLENDER PATTERN
CS 10135 - 305 MM - 12"

Very Delicate Micro Needle Holder With TC Tips



Basic Instruments

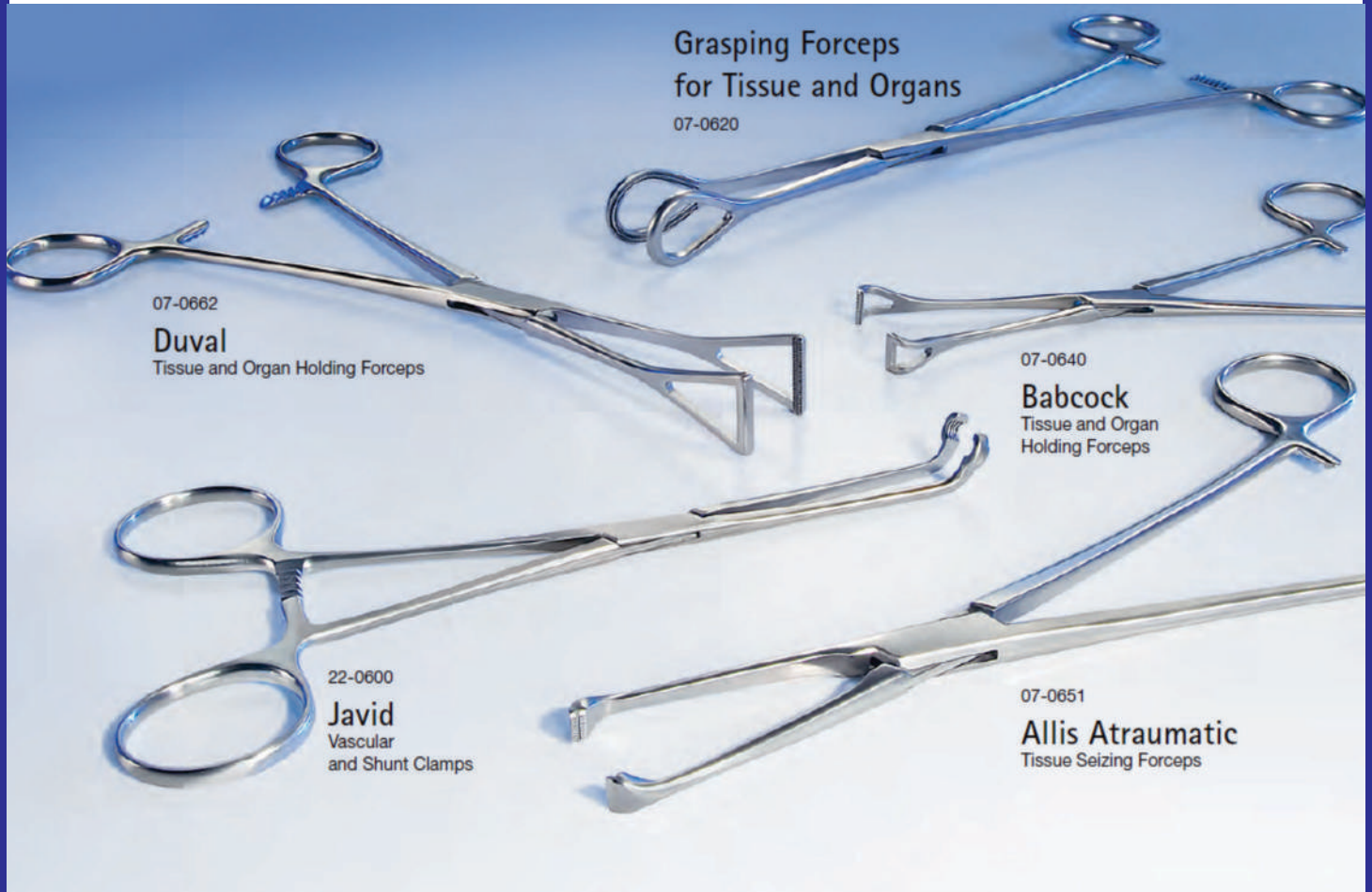

Grasping Forceps
for Tissue and Organs
07-0620

07-0662
Duval
Tissue and Organ Holding Forceps

07-0640
Babcock
Tissue and Organ
Holding Forceps

22-0600
Javid
Vascular
and Shunt Clamps

07-0651
Allis Atraumatic
Tissue Seizing Forceps



Javid Vascular and Shunt Clamps							
A	22-0600	17 cm/6½"					
B	22-0601	19 cm/7½"					
Allis Atraumatic Tissue Seizing Forceps							
C	07-0650	15.5 cm/6"					
	07-0651	20.0 cm/8"					
	07-0652	22.0 cm/8½"					
	07-0653	25.0 cm/10"					
	07-0654	30.0 cm/12"					
D	07-0830	15.0 cm/6"					
	07-0831	19.0 cm/7½"					
Babcock Tissue and Organ Holding Forceps							
E	07-0640	16 cm/6¼"					
	07-0641	21 cm/8¼"					
F	07-0800	16 cm/6¼"					
	07-0802	20 cm/8"					
Duval Tissue and Organ Holding Forceps							
G	07-0660	20.5 cm/8"					
H	07-0662	20.5 cm/8"					
Grasping Forceps for Tissue and Organs							
I	07-0620	24 cm/9½"					
J	07-0622	26 cm/10¼"					



Basic Instruments

DeBakey-Rankin

22-1230

DeBakey-Pean

22-1242



22-1210

DeBakey-Mosquito

22-1225

DeBakey-Kelly

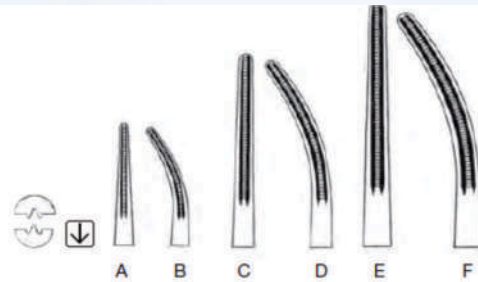

DeBakey-Mosquito

- A 22-1210 12 cm/4½"
- B 22-1211 12 cm/4½"

DeBakey-Kelly

- C 22-1220 14 cm/5½"
- D 22-1225 14 cm/5½"

DeBakey-Rankin

- E 22-1230 16 cm/6¼"
- F 22-1231 16 cm/6¼"

DeBakey-Pean

- G 22-1239 14 cm/5½"
- H 22-1240 16 cm/6¼"
- I 22-1241 18 cm/7"
- J 22-1242 20 cm/8"
- K 22-1244 26 cm/10½"
- L 22-1246 28 cm/11"
- M 22-1249 14 cm/5½"
- N 22-1250 16 cm/6¼"
- O 22-1251 18 cm/7"
- P 22-1252 20 cm/8"
- Q 22-1254 26 cm/10½"
- R 22-1256 28 cm/11"

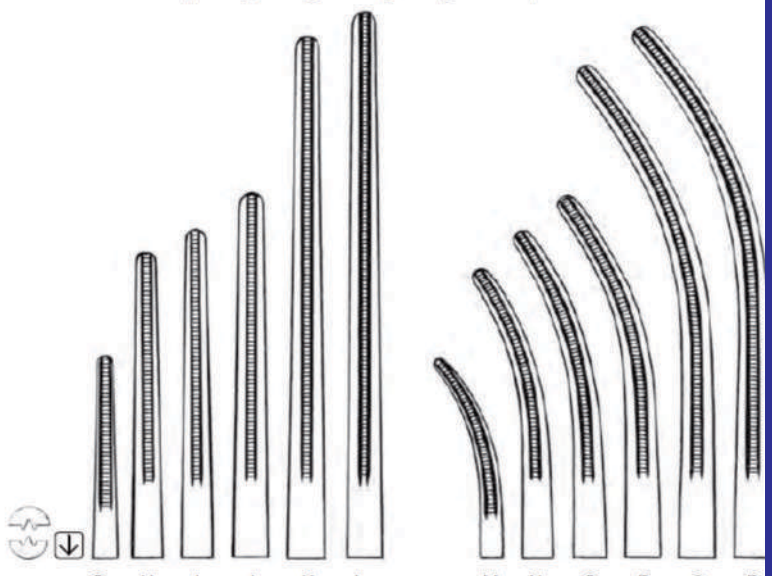



Basic Instruments

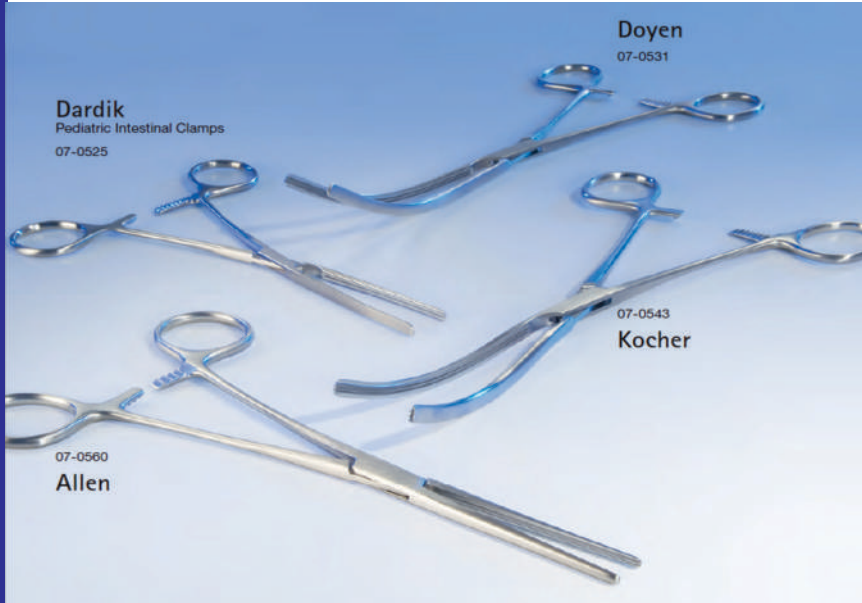

Dardik
Pediatric Intestinal Clamps
07-0525

Doyen
07-0531

Kocher
07-0543

07-0560
Allen

Allen		
A 07-0560	20.5 cm/8"	
07-0562	23 cm/9"	

Dardik		
Pediatric Intestinal Clamps		
B 07-0526	17.5 cm/6½"	
C 07-0525	17.5 cm/6½"	

Doyen/Baby-Doyen/Mayo-Robson		
D Baby-Doyen		
07-0520	17.5 cm/6½"	
E Doyen		
07-0530	24 cm/9½"	
F Mayo-Robson		
07-0535	25 cm/10"	
G Baby-Doyen		
07-0521	17.5 cm/6½"	
H Doyen		
07-0531	23 cm/9"	
I Mayo-Robson		
07-0536	25 cm/10"	

Kocher		
J 07-0540	22 cm/8½"	
07-0541	25 cm/10"	
07-0542	28 cm/11"	
K 07-0543	21.5 cm/8¼"	
07-0544	24.5 cm/9½"	
M 07-0545	27 cm/10½"	

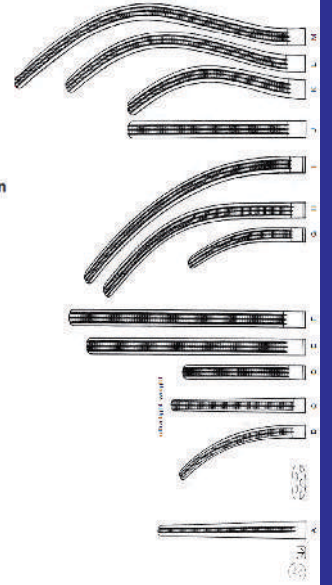

Halstead-Mosquito
25-1060

Micro-Halstead-Mosquito
25-1021

25-1060
Baby-Mosquito
(Hartmann)

25-1016
Micro-Mosquito

25-1071
Halstead-Mosquito

Micro-Mosquito		
A 25-1010	10 cm/4"	
B 25-1011	10 cm/4"	
C 25-1015	10 cm/4"	
D 25-1016	10 cm/4"	

Micro-Halstead-Mosquito		
E 25-1020	12.5 cm/5"	
F 25-1021	25-1021.TI	12.5 cm/5"
G 25-1025		12.5 cm/5"
H 25-1026	25-1026.TI	12.5 cm/5"
I 25-1030		14 cm/5½"
J 25-1031		14 cm/5½"
K 25-1035		14 cm/5½"
L 25-1036		14 cm/5½"

Baby-Mosquito (Hartmann)		
M 25-1060	25-1060.TI	9 cm/3½"
N 25-1061	25-1061.TI	9 cm/3½"

Halstead-Mosquito		
O 25-1070	25-1070.TI	12.5 cm/5"
P 25-1071	25-1071.TI	12.5 cm/5"
Q 25-1075	25-1075.TI	12.5 cm/5"
R 25-1076	25-1076.TI	12.5 cm/5"
S 25-1080		18 cm/7"
T 25-1081		18 cm/7"
U 25-1085		18 cm/7"
V 25-1086		18 cm/7"
W 25-1090		20 cm/8"
X 25-1091		20 cm/8"
Y 25-1092		20 cm/8"
Z 25-1093		20 cm/8"

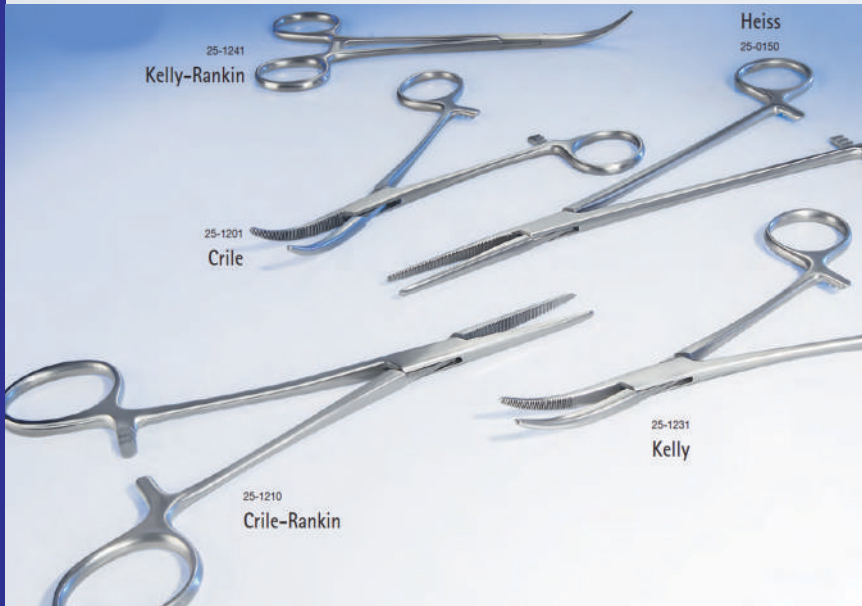
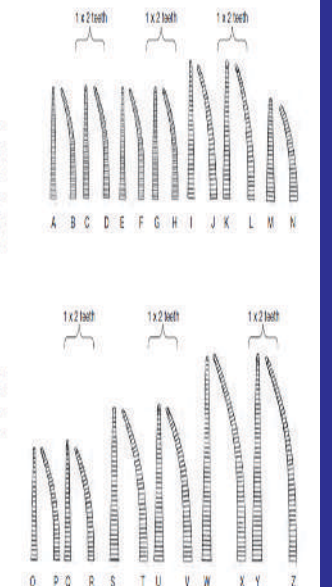

25-1241
Kelly-Rankin

Heiss
25-0150

25-1201
Crile

25-1231
Kelly

25-1210
Crile-Rankin

Heiss		
A 25-0150	20 cm/8"	
B 25-0151	20 cm/8"	
C 25-0152	20 cm/8"	

Kelly		
D 25-1230	14 cm/5½"	
E 25-1231	14 cm/5½"	

Kelly-Rankin		
F 25-1240	16 cm/6¼"	
G 25-1241	16 cm/6¼"	

Crile		
H 25-1200	14 cm/5½"	
25-1200.TI		
I 25-1201	14 cm/5½"	
25-1201.TI		
J 25-1205	14 cm/5½"	
K 25-1206	14 cm/5½"	

Crile-Rankin		
L 25-1210	16 cm/6¼"	
M 25-1211	16 cm/6¼"	

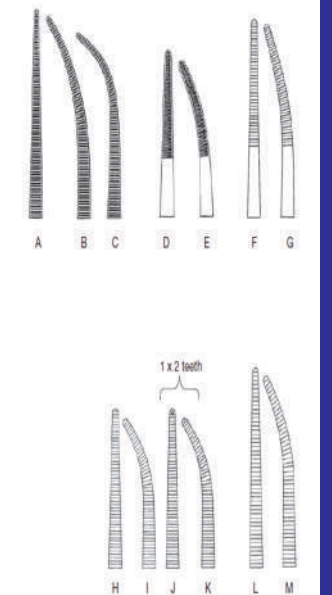



Basic Instruments

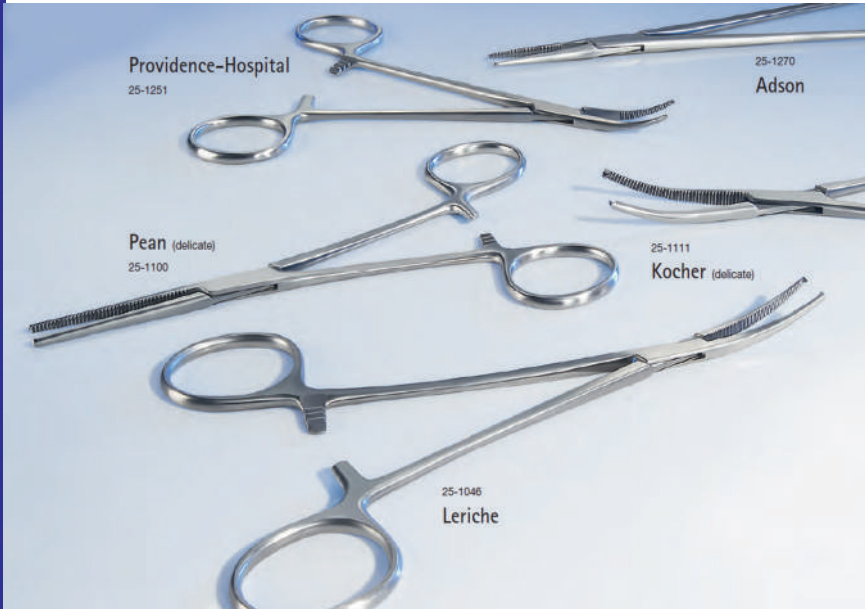

- Leriche**
- A 25-1040 15 cm/6"
 - B 25-1041 15 cm/6"
 - C 25-1045 15 cm/6"
 - D 25-1046 15 cm/6"

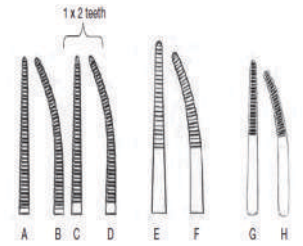

- Adson**
- E 25-1270 19 cm/7½"
 - F 25-1271 19 cm/7½"

- Providence-Hospital**
- G 25-1250 13 cm/5"
 - H 25-1251 13 cm/5"



- Kocher (delicate)**
- I 25-1110 14.5 cm/5½"
 - J 25-1111 14.5 cm/5½"

- Pean (delicate)**
- K 25-1100 14.5 cm/5½"
 - L 25-1101 14.5 cm/5½"

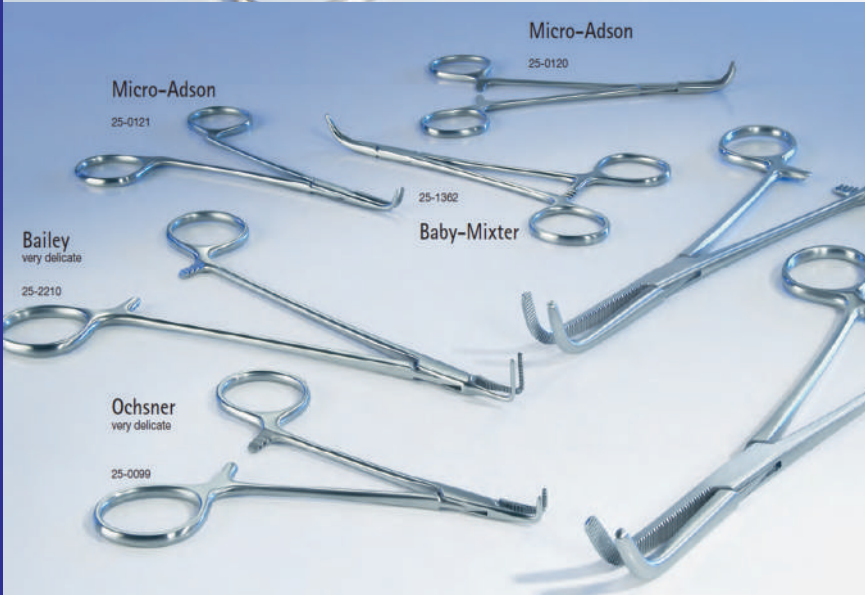

- Baby-Mixer**
- A 25-1360 14 cm/5½"
 - B 25-1361 14 cm/5½"
 - C 25-1362 14 cm/5½"
 - D 25-1363 18 cm/7"

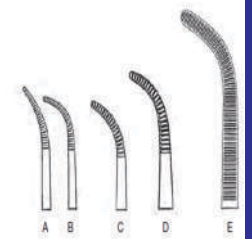

- Mixer-O'Shaughnessy**
- E 25-1365 19 cm/7½"

- Mixer**
- F 25-1370 16 cm/6¼"
 - G 25-1371 19.5 cm/7½"
 - H 25-1372 21.5 cm/8¼"

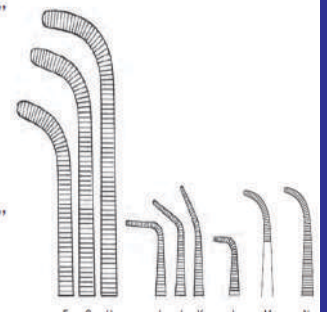

- Bailey very delicate**
- I 25-2210 18 cm/7"
 - J 25-2211 18 cm/7"
 - K 25-2212 18 cm/7"

- Ochsner very delicate**
- L 25-0099 11.5 cm/4¼"

- Micro-Adson**
- M 25-0120 14 cm/5½"
 - N 25-0121 14 cm/5½"

- Roberts**
- A 25-1330 22 cm/8½"
 - B 25-1331 22 cm/8½"



- Schmidt**
- C 25-1340 19 cm/7½"

- Mixer**
- D 25-0126 23 cm/9"

- DeBakey-Mixer (Gemini)**
- E 25-0100 14 cm/5½"
 - F 25-0101 16 cm/6¼"
 - G 25-0102 18 cm/7"
 - H 25-0103 20 cm/8"
 - I 25-0104 23 cm/9"
 - J 25-0105 25 cm/10"
 - K 25-0106 28 cm/11"

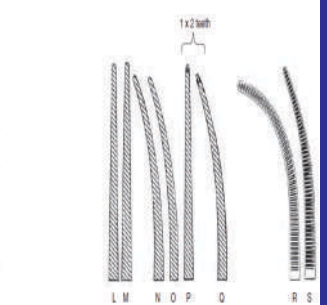

- Bengolea**
- L 25-0200 24 cm/9½"
 - M 25-0205 26 cm/10¼"
 - N 25-0201 24 cm/9½"
 - O 25-0206 26 cm/10¼"
 - P 25-0202 24 cm/9½"
 - Q 25-0204 24 cm/9½"

- Zenker**
- R 25-1291 29 cm/11½"
 - S 25-1290 30 cm/12"

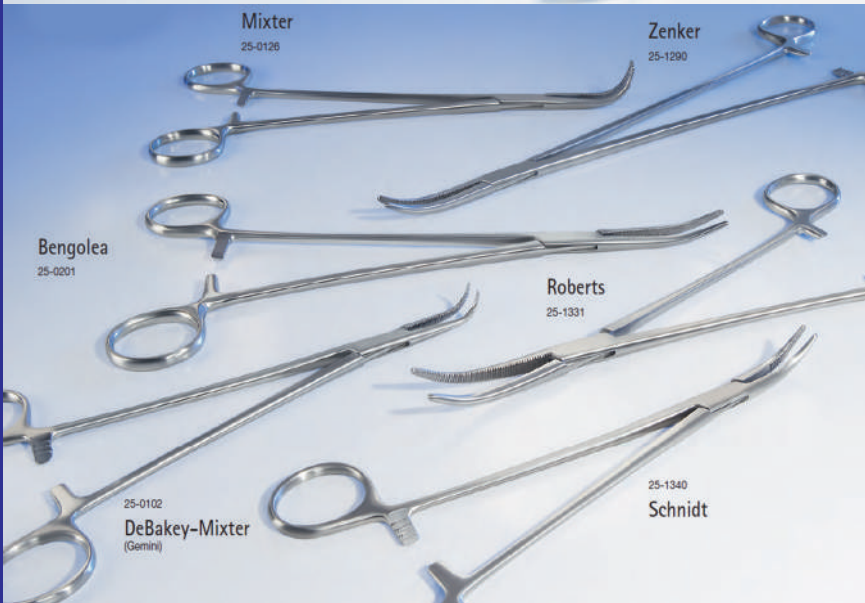



Basic Instruments

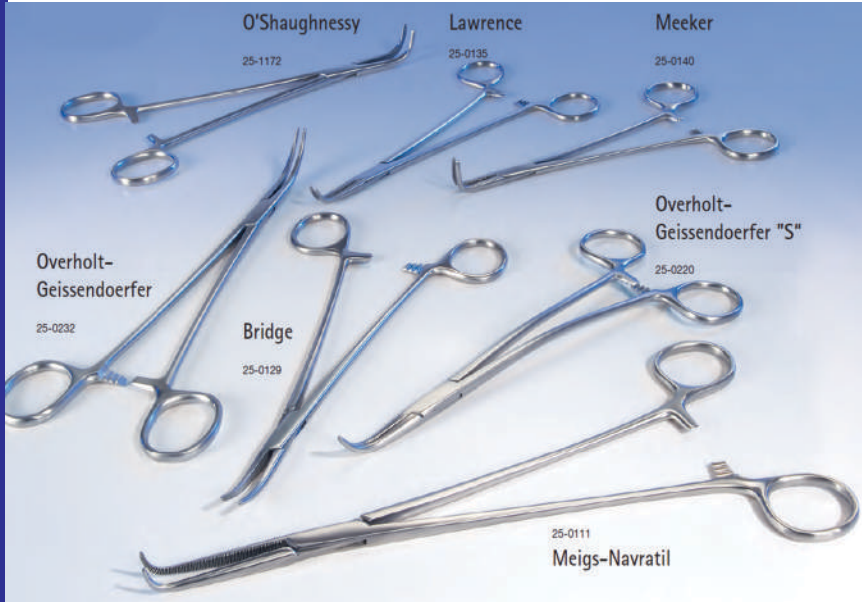

Bridge	
A 25-0129	18 cm/7"
25-0130	28 cm/11"
B 25-0129	18 cm/7"
25-0131	28 cm/11"
Meeker	
C 25-0140	18 cm/7"
25-0141	28 cm/11"
Lawrence	
D 25-0135	19 cm/7½"
25-0136	28 cm/11"
Overholt-Geissendoerfer	
E 25-0230	19.5 cm/7½"
25-0240	26 cm/10½"
F 25-0231	21 cm/8½"
25-0241	27 cm/10½"
G 25-0232	22 cm/8½"
25-0242	27.5 cm/10½"
H 25-0233	22.5 cm/8½"
25-0243	27.5 cm/10½"
I 25-0234	21.5 cm/8½"
25-0244	27.5 cm/10½"
J 25-0235	22.5 cm/8½"
25-0245	28 cm/11"
K 25-0236	22.5 cm/8½"
25-0246	27.5 cm/10½"
Overholt-Geissendoerfer "S"	
L 25-0220	18.5 cm/7"
M 25-0221	20.5 cm/8"
N 25-0222	21 cm/8½"
O 25-0223	21.5 cm/8½"
Meigs-Navratil	
P 25-0110	18 cm/7"
Q 25-0111	22 cm/8½"
R 25-0112	25 cm/10"
S 25-0113	28 cm/11"
O'Shaughnessy	
T 25-1170	15 cm/6"
25-1171	18 cm/7"
25-1172	20 cm/8"
25-1174	23 cm/9"
25-1176	25 cm/10"
25-1178	28 cm/11"

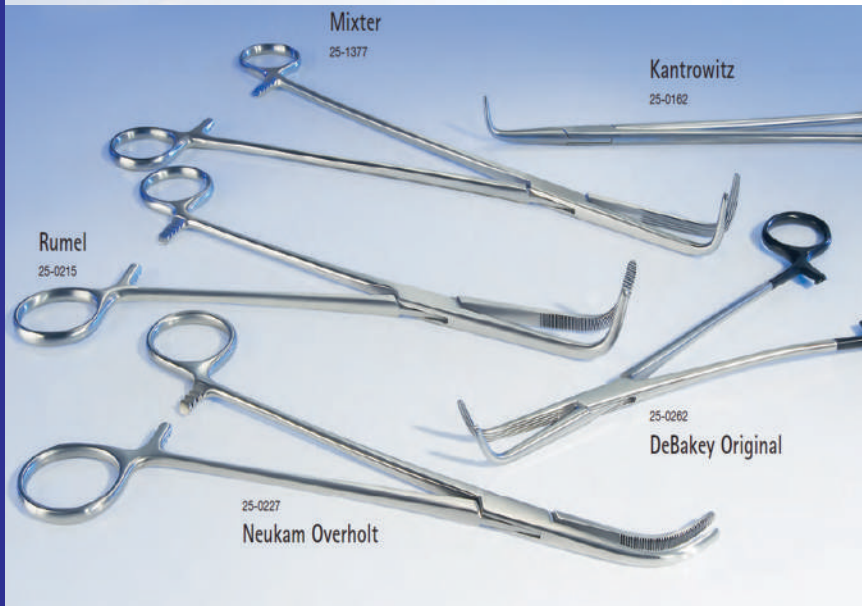
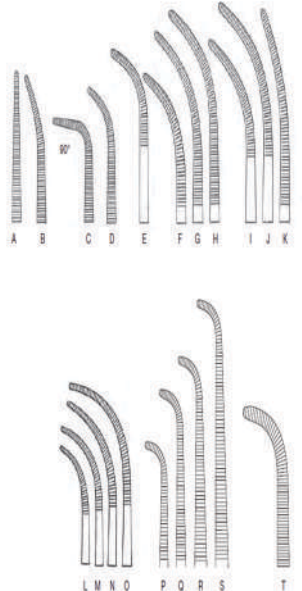

A 25-0211	24 cm/9½"	
B 25-0212	24 cm/9½"	
C 25-0213	24 cm/9½"	
D 25-0214	24 cm/9½"	
E 25-0215	24 cm/9½"	
Kantrowitz		
F 25-0160	19 cm/7½"	
G 25-0162	24 cm/9½"	
H 25-0164	27 cm/10½"	
DeBakey Original		
I 25-0262	19 cm/7½"	
J 25-0260	25 cm/10"	
Neukam Overholt		
K 25-0227	22 cm/8½"	
25-0228	28 cm/11"	
Mixer		
L 25-1375	21.5 cm/8½"	
25-1376	25.5 cm/10"	
M 25-1377	28 cm/11"	
25-1378	32 cm/12½"	
DeBakey-Coolley Haemostatic Forceps		
N 25-0325	35.5 cm/14"	straight jaws
O 25-0300	19 cm/7½"	curved jaws
25-0301	23 cm/9"	curved jaws
25-0302	25 cm/10"	curved jaws
25-0303	28 cm/11"	curved jaws
25-0304	30.5 cm/12"	curved jaws
25-0305	35.5 cm/14"	curved jaws
P 25-0310	19 cm/7½"	right angled jaws
25-0311	23 cm/9"	right angled jaws
25-0312	25 cm/10"	right angled jaws
25-0313	28 cm/11"	right angled jaws
25-0314	30.5 cm/12"	right angled jaws
25-0315	35.5 cm/14"	right angled jaws

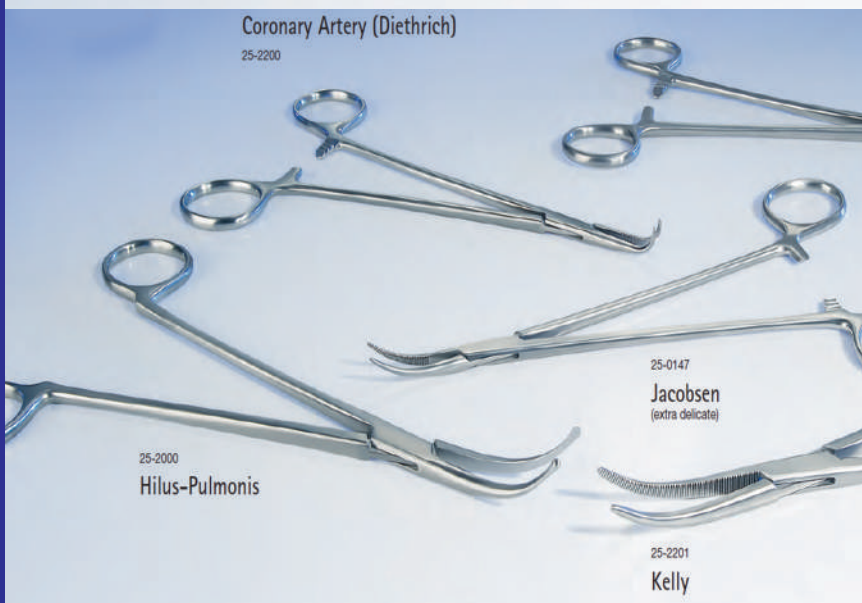
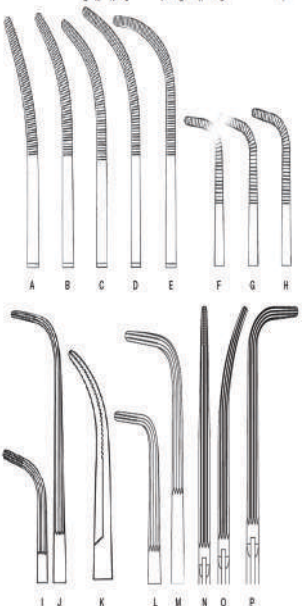

A 25-0144	13 cm/5"
B 25-0145	13 cm/5"
C 25-0147	19 cm/7½"
D 25-0148	19 cm/7½"
Hilus-Pulmonis	
E 25-2000	20 cm/8"
Coronary Artery (Diethrich)	
F 25-2200	18.5 cm/7"
Dunhill's (UK)	
G 25-1381	12.5 cm/5"
H 25-1383	18 cm/7"
Kelly	
I 25-2201	19 cm/7½"
25-2204	22 cm/8½"
25-2207	24 cm/9½"
J 25-2202	19 cm/7½"
25-2205	22 cm/8½"
25-2208	24 cm/9½"
K 25-2203	19 cm/7½"
25-2206	22 cm/8½"
25-2209	24 cm/9½"

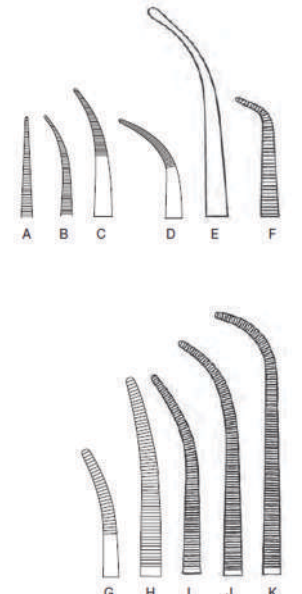



Basic Instruments

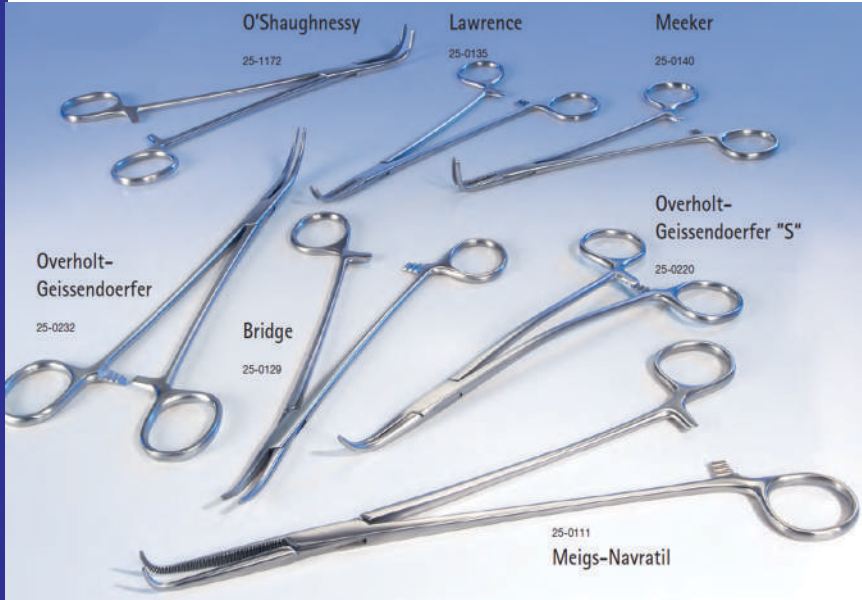

Bridge		
A	25-0128	18 cm/7"
	25-0130	28 cm/11"
B	25-0129	18 cm/7"
	25-0131	28 cm/11"
Meeker		
C	25-0140	18 cm/7"
	25-0141	28 cm/11"
Lawrence		
D	25-0135	19 cm/7½"
	25-0136	28 cm/11"
Overholt-Geissendoerfer		
E	25-0230	19.5 cm/7½"
	25-0240	26 cm/10¼"
F	25-0231	21 cm/8¼"
	25-0241	27 cm/10½"
G	25-0232	22 cm/8½"
	25-0242	27.5 cm/10½"
H	25-0233	22.5 cm/8¾"
	25-0243	27.5 cm/10½"
I	25-0234	21.5 cm/8½"
	25-0244	27.5 cm/10½"
J	25-0235	22.5 cm/8¾"
	25-0245	28 cm/11"
K	25-0236	22.5 cm/8¾"
	25-0246	27.5 cm/10½"
Overholt-Geissendoerfer "S"		
L	25-0220	18.5 cm/7"
M	25-0221	20.5 cm/8"
N	25-0222	21 cm/8¼"
O	25-0223	21.5 cm/8½"
Meigs-Navratil		
P	25-0110	18 cm/7"
Q	25-0111	22 cm/8½"
R	25-0112	25 cm/9"
S	25-0113	28 cm/11"
O'Shaughnessy		
T	25-1170	15 cm/6"
	25-1171	18 cm/7"
	25-1172	20 cm/8"
	25-1174	23 cm/9"
	25-1176	25 cm/10"
	25-1178	28 cm/11"

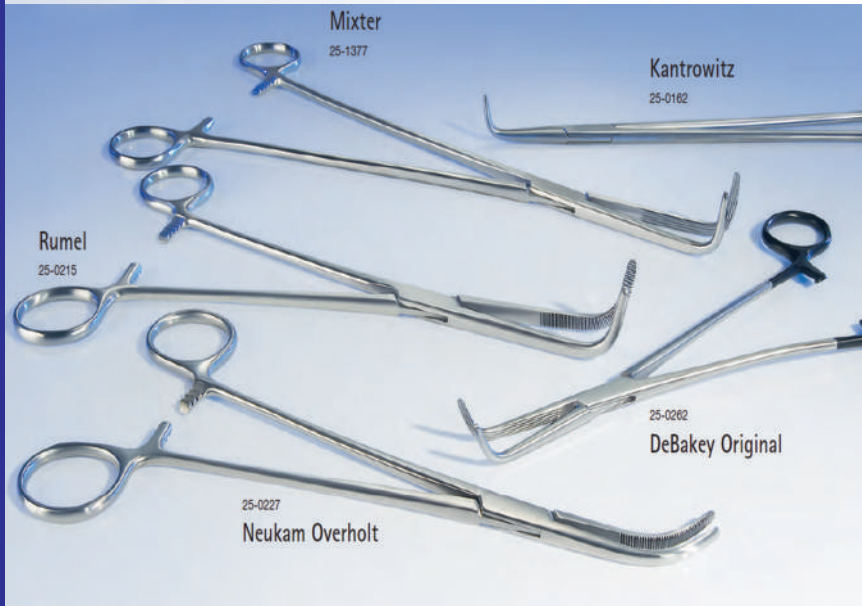
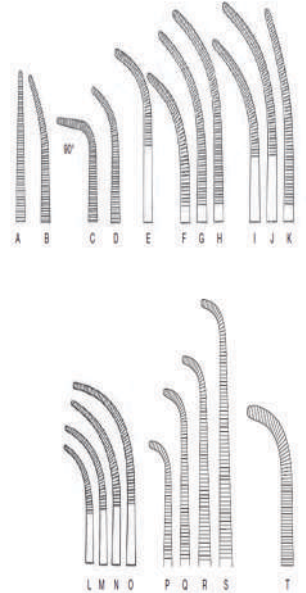

Rumel			
A	25-0211	24 cm/9½"	
B	25-0212	24 cm/9½"	
C	25-0213	24 cm/9½"	
D	25-0214	24 cm/9½"	
E	25-0215	24 cm/9½"	
Kantrowitz			
F	25-0160	19 cm/7½"	
G	25-0162	24 cm/9½"	
H	25-0164	27 cm/10½"	
DeBakey Original			
I	25-0262	19 cm/7½"	
J	25-0260	25 cm/10"	
Neukam Overholt			
K	25-0227	22 cm/8½"	
	25-0228	28 cm/11"	
Mixer			
L	25-1375	21.5 cm/8½"	
	25-1376	25.5 cm/10"	
M	25-1377	28 cm/11"	
	25-1378	32 cm/12½"	
DeBakey-Cooley Haemostatic Forceps			
N	25-0325	35.5 cm/14"	straight jaws
O	25-0300	19 cm/7½"	curved jaws
	25-0301	23 cm/9"	curved jaws
	25-0302	25 cm/10"	curved jaws
	25-0303	28 cm/11"	curved jaws
	25-0304	30.5 cm/12"	curved jaws
	25-0305	35.5 cm/14"	curved jaws
P	25-0310	19 cm/7½"	right angled jaws
	25-0311	23 cm/9"	right angled jaws
	25-0312	25 cm/10"	right angled jaws
	25-0313	28 cm/11"	right angled jaws
	25-0314	30.5 cm/12"	right angled jaws
	25-0315	35.5 cm/14"	right angled jaws

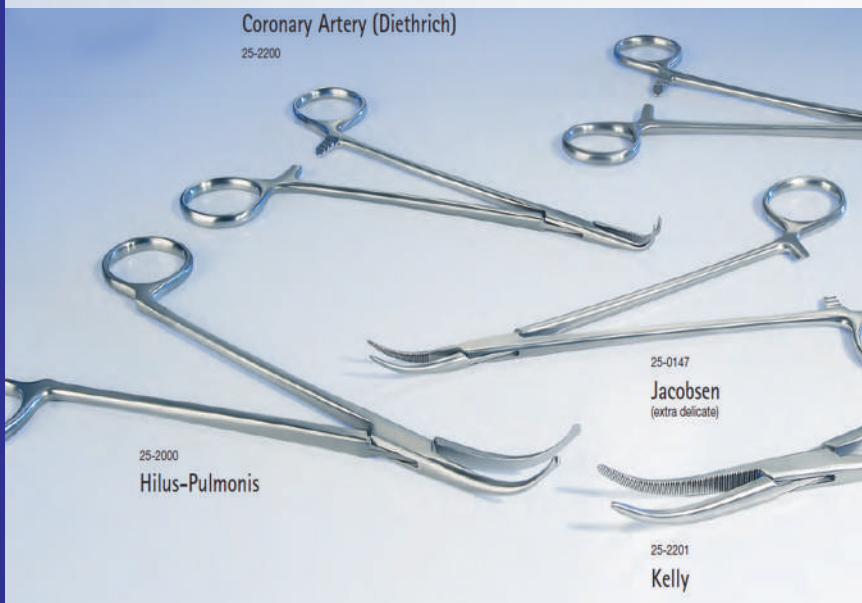
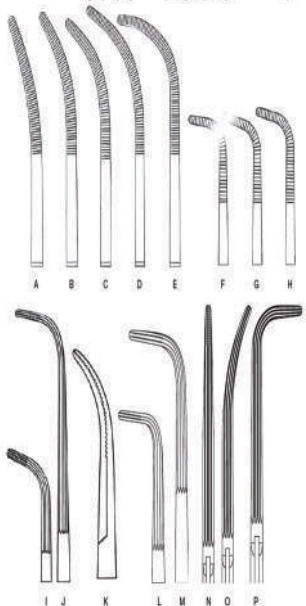

Jacobsen (extra delicate)		
A	25-0144	13 cm/5"
B	25-0145	13 cm/5"
C	25-0147	19 cm/7½"
D	25-0148	19 cm/7½"
Hilus-Pulmonis		
E	25-2000	20 cm/8"
Coronary Artery (Diethrich)		
F	25-2200	18.5 cm/7"
Dunhill's (UK)		
G	25-1381	12.5 cm/5"
H	25-1383	18 cm/7"
Kelly		
I	25-2201	19 cm/7½"
	25-2204	22 cm/8½"
	25-2207	24 cm/9½"
J	25-2202	19 cm/7½"
	25-2205	22 cm/8½"
	25-2208	24 cm/9½"
K	25-2203	19 cm/7½"
	25-2206	22 cm/8½"
	25-2209	24 cm/9½"

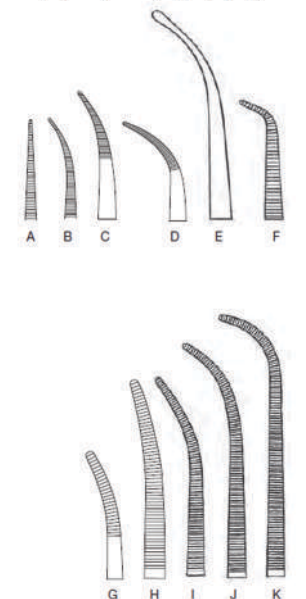



Surgitech

CLASSIC, EXCLUSIVE & ELEGANCE STYLE SURGICAL INSTRUMENTS

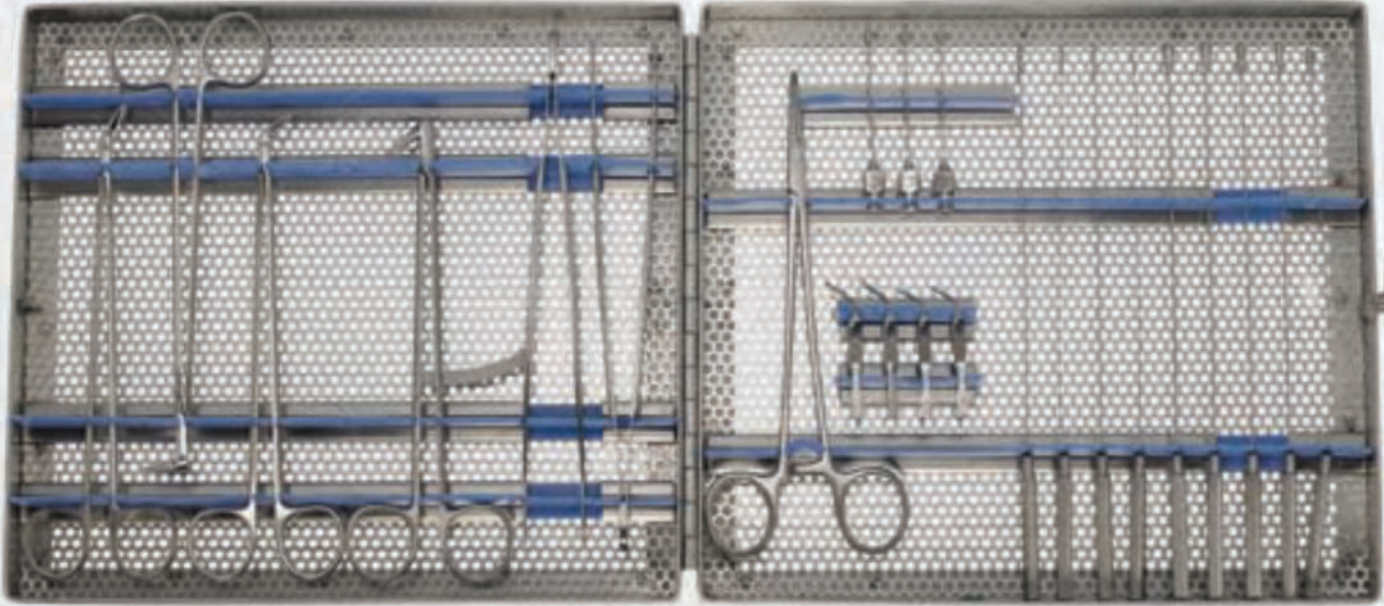

DIETRICH Coronary Artery Bypass Kit

DIETRICH Coronary Artery Bypass Kit Includes:

- Coronary Artery Scissors, 7" (17.8cm), 25° angle
- Coronary Artery Scissors, 7" (17.8cm), 45° angle
- Coronary Artery Scissors, 7" (17.8cm), 60° angle
- Coronary Artery Scissors, 7" (17.8cm), 90° angle
- Circumflex Artery Scissors, 7" (17.8cm), 130° angle

- Gemini Clamp, 7" (17.8cm)
- DeBakey-Diethrich Coronary Artery Forceps, 7.75" (19.7cm)
- Diethrich Micro-Coronary Bulldog Clamps, 8mm
- Diethrich Micro-Coronary Bulldog Clamps, 12mm
- Heparin Flushing Needles, 2" (5.1cm)
- Set of 9 Garrett Vascular Dilators, 8.25" (21cm)
- Sterilizing case

Bulldog Clamps



- 5.2cm length, 10mm angled jaws
- 5.2cm length, 10mm straight jaws
- 5.4cm length, 12mm angled jaws
- 5.6cm length, 12mm straight jaws
- 6.0cm length, 20mm angled jaws
- 6.4cm length, 20mm straight jaws



- 7.5cm, straight, jaw length 2cm
- 8.5cm, straight, jaw length 3cm
- 0.5cm, straight, jaw length 4.5cm
- 12cm, straight, jaw length 6.5cm
- 7.5cm, curved, jaw length 2cm
- 8.5cm, curved, jaw length 3cm
- 10.5cm, curved, jaw length 4.5cm
- 12cm, curved, jaw length 6.5cm

Cornary Probe

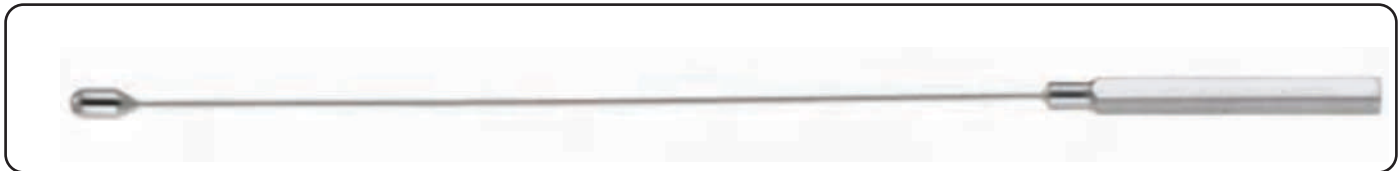

- | | |
|-------------|------------|
| 1.0 mm size | 1.5mm size |
| 2.0mm size | 2.5mm size |
| 3.0mm size | 3.5mm size |
| 4.0mm size | 4.5mm size |
| 5.0mm size | |

DeBAKEY Heparin Cannula



2 1/8" (5.4cm), malleable, 2.7mm tip



Surgitech

CLASSIC, EXCLUSIVE & ELEGANCE STYLE SURGICAL INSTRUMENTS

WEITLANER Retractors, Hinged Blades

- 5 1/2" (14cm), 3 x 4 sharp prongs, 17mm deep
- 5 1/2" (14cm), 3 x 4 blunt prongs, 17mm deep
- 6 1/4" (15.9cm), 3 x 4 sharp prongs, 18mm deep
- 6 1/4" (15.9cm), 3 x 4 blunt prongs, 18mm deep
- 8" (20.3cm), 3 x 4 sharp prongs, 20mm deep



ADSON Cerebellar Retractors, 7 1/2" (19.1cm)

- 4 x 4 sharp prongs, 22mm deep
- 4 x 4 blunt prongs, 22mm deep



ADSON Cerebellar Retractors, 7 1/4" (18.4cm), Angled

- 4 x 4 sharp prongs, 22mm deep
- 4 x 4 blunt prongs, 22mm deep

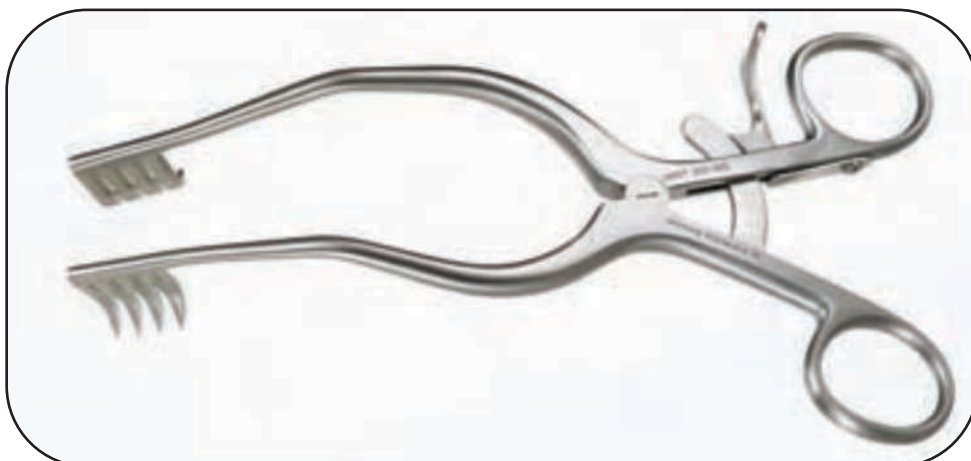

LAD PIN 3 x 3 Sharp Prongs

- 1 7/8" (4.8cm)
- 1 1/2" (3.8cm)
- 1 1/4" (3.2cm)
- 1" (2.5cm)

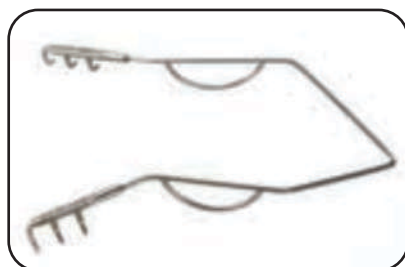



Surgitech

CLASSIC, EXCLUSIVE & ELEGANCE STYLE SURGICAL INSTRUMENTS

COOLEY Atrial Valve Retractors

Right, width 7/8" (2.2cm), depth 1 7/8" (4.8cm)
Right, width 1 1/2" (3.8cm), depth 2" (4.8cm)
Right, width 2" (4.8cm), depth 1 3/4" (4.5cm)
Left, width 2" (5.1cm), depth 1" (2.5cm)



ALLISON Lung Retractors

Large, 12 1/2" (32cm), 2 1/8" wide (5.4cm)
Small, 10 1/4" (26cm), 1 1/2" wide (3.8cm)



DOYEN Rasps, 6 1/2" (16.5cm)

Small, left
Small, right
Large, left
Large, right

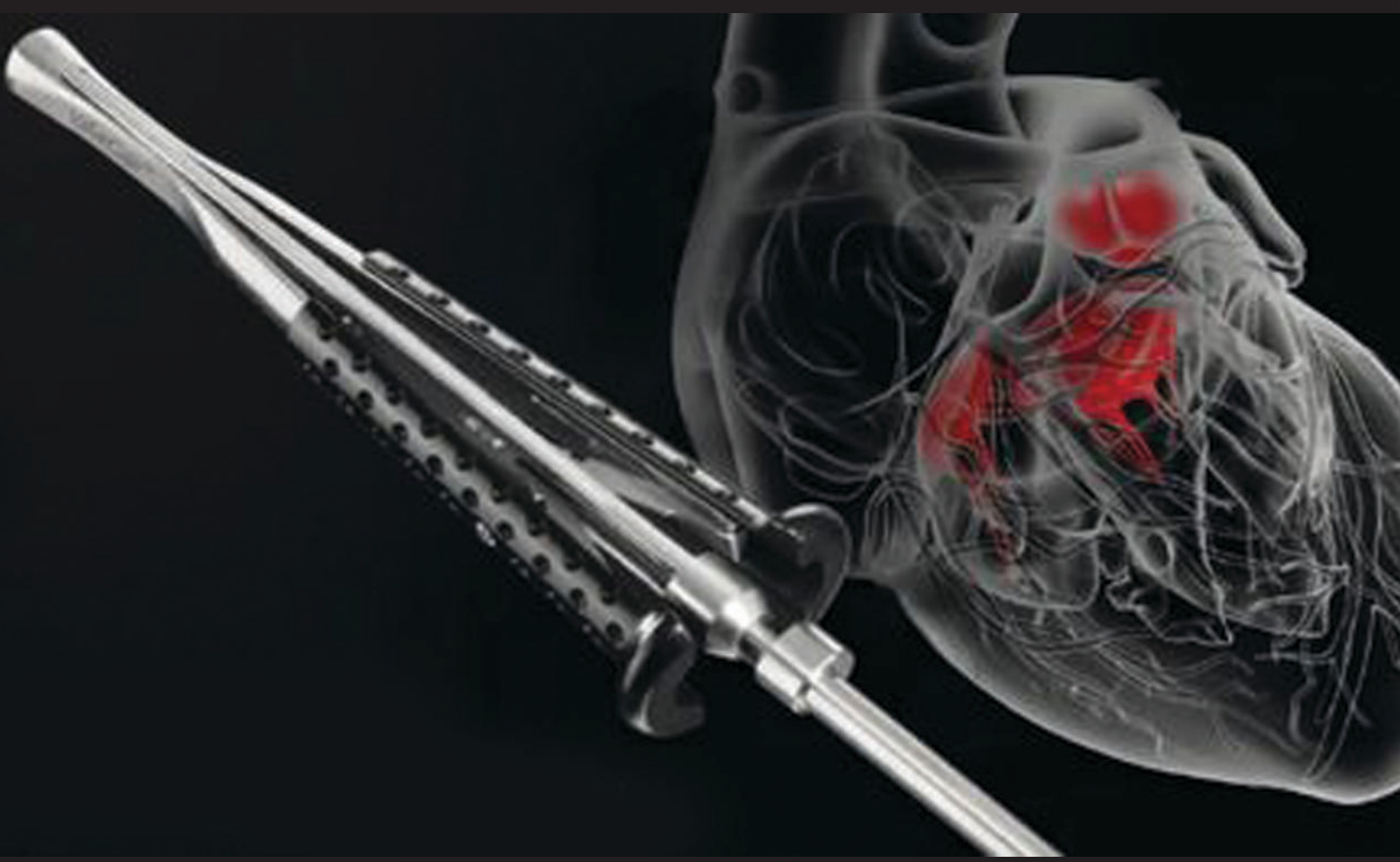

CUSTOMIZED SOLUTION FOR MICS SURGERY



Surgitech Healthcare Pvt. Ltd. MICS

CLASSIC, EXCLUSIVE & ELEGANCE STYLE SURGICAL INSTRUMENTS



Surgitech

CLASSIC, EXCLUSIVE & ELEGANCE STYLE SURGICAL INSTRUMENTS

MICS Set for MVR





Surgitech

CLASSIC, EXCLUSIVE & ELEGANCE STYLE SURGICAL INSTRUMENTS

CUSTOMIZED INSTRUMENTS FOR MICS

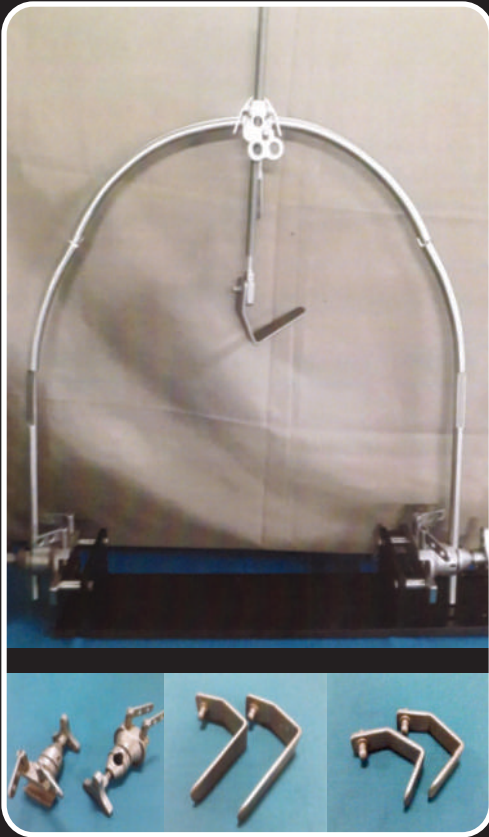

Round Shape Chest Lifting System
(IMA Retractor)

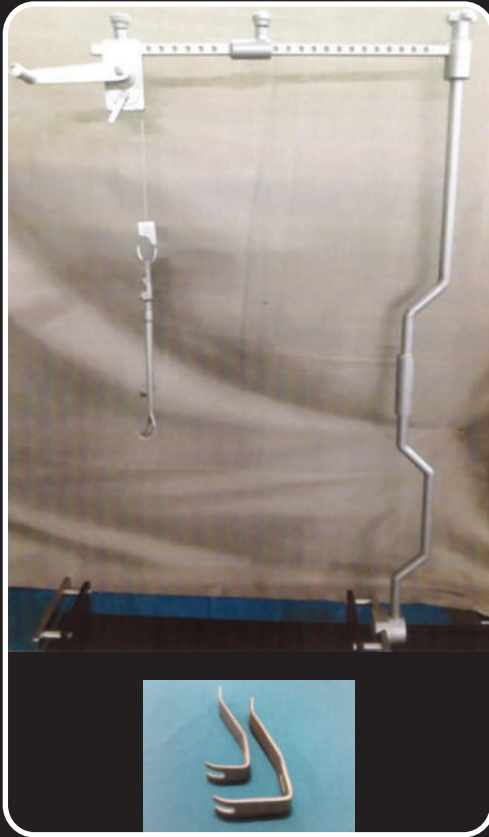

Rultract System with RIMA Blades

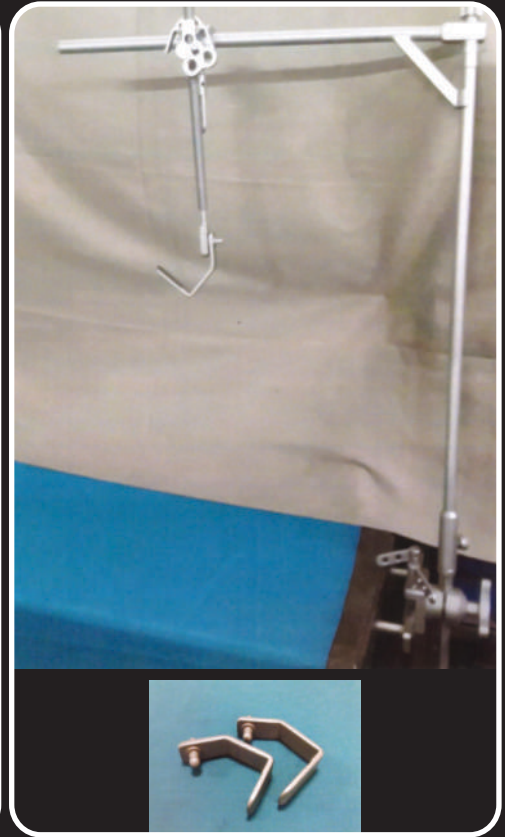

Single Post Chest Lifting System with
RIMA Blades

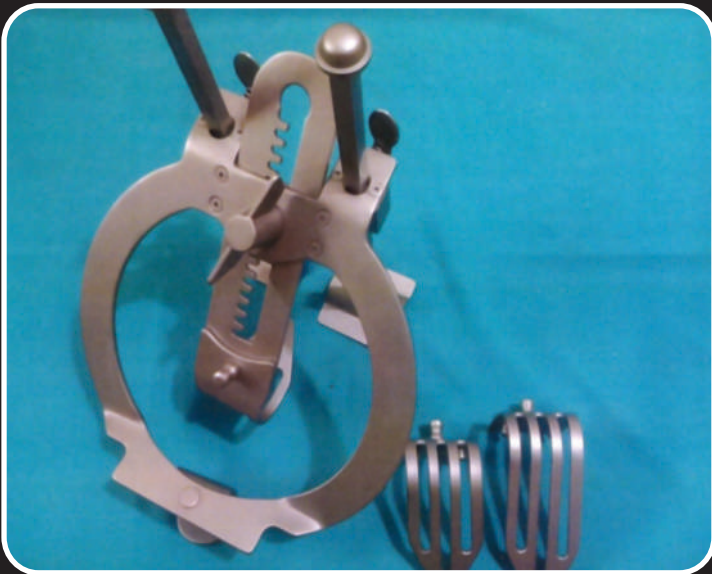

MIDCAB Retractor with LIMA and RIMA Harvesting Blades



IMA RETRACTOR



MICS RETRACTOR





Surgitech

CLASSIC, EXCLUSIVE & ELEGANCE STYLE SURGICAL INSTRUMENTS

CUSTOMIZED INSTRUMENTS FOR MICS



MICS OCTOPUS EVO 360



TITANIUM RESAUELE HEART STABLIZER



ENDOSCOPE HOLDER

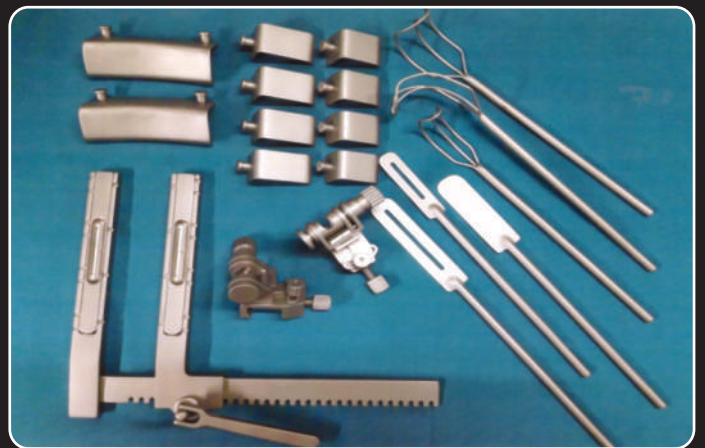

MITRAL VALVE RECTRACTOR FOR OPEN SURGERY

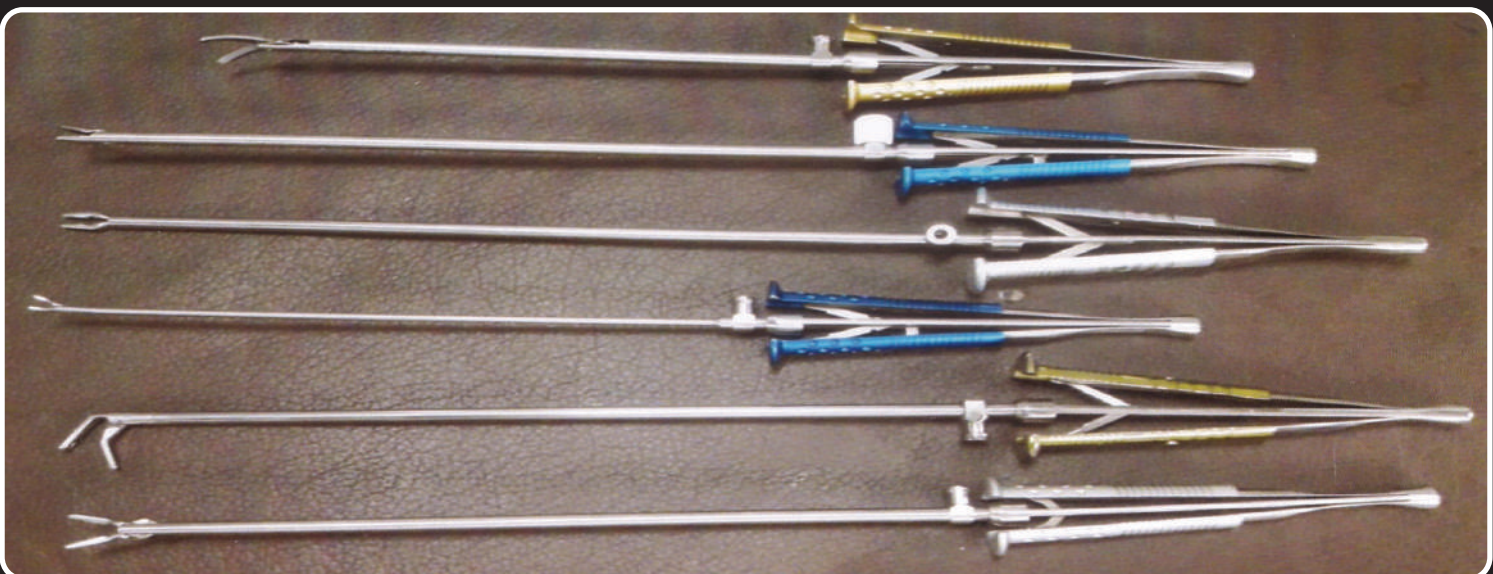

MICS LONG AXIAL INSTRUMENTS



Surgitech

CLASSIC, EXCLUSIVE & ELEGANCE STYLE SURGICAL INSTRUMENTS

CUSTOMIZED INSTRUMENTS FOR MICS

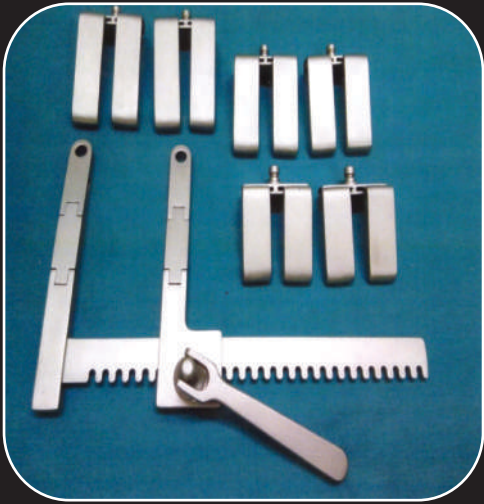

**TWIN BLADE
MICS RETRACTOR**



TILTABLE MICS RETRACTOR

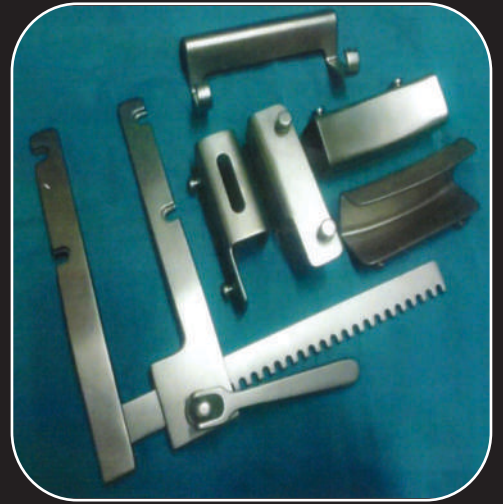

MAMMARIA RETRACTOR



**SUTURE HOLDING RING
MICS**



**ENDARTERECTOMY
PROBES AND DISSECTOR SET**



**MICS VALVE HOOKS
AND BP HANDLE**

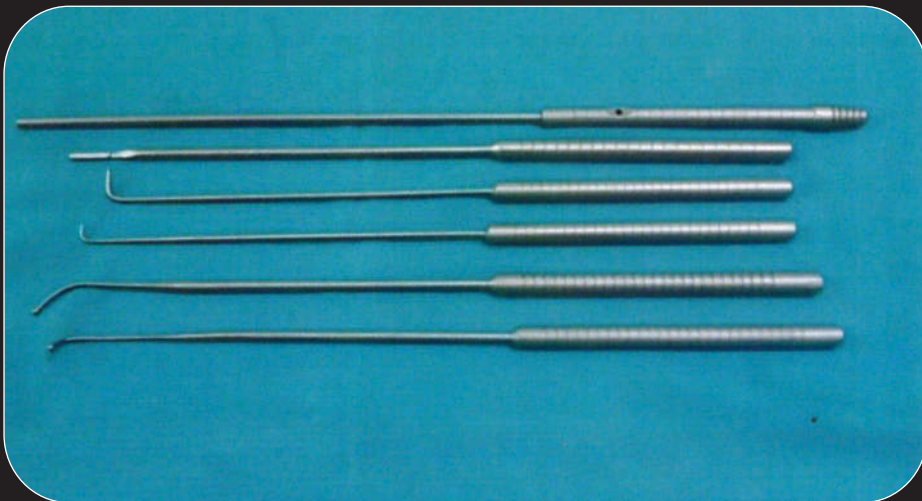

MICS VALVE HOOKS AND BP HANDLE

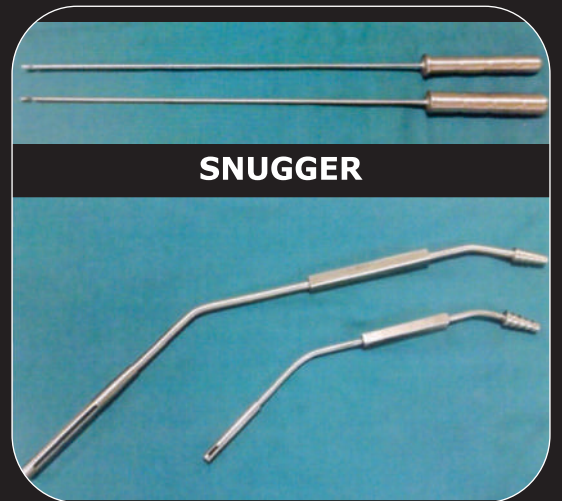

SNUGGER

SUCTION CANNUALS

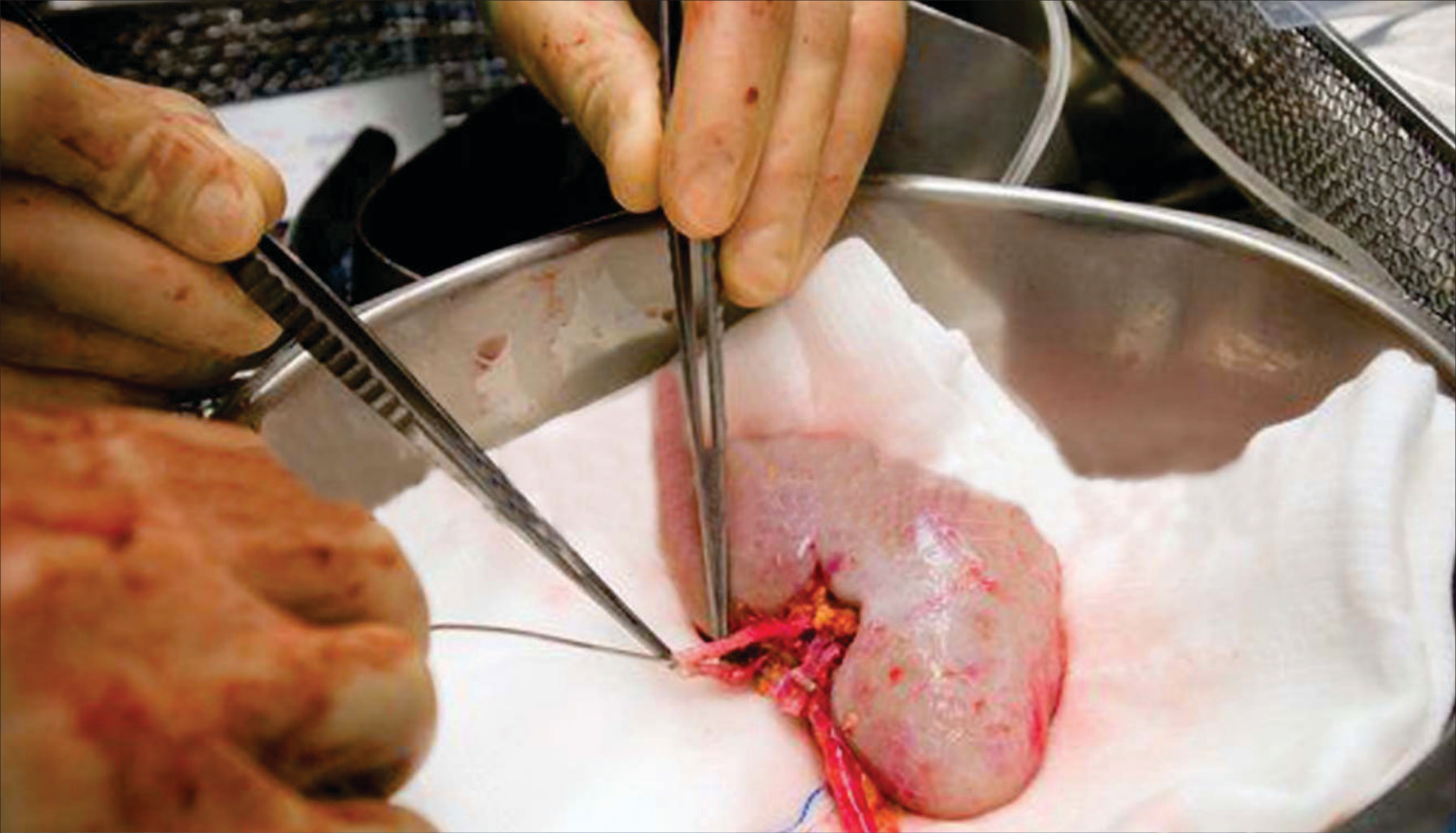

Surgitech Healthcare Pvt. Ltd.

**Kidney
Transplant**

CLASSIC, EXCLUSIVE & ELEGANCE STYLE SURGICAL INSTRUMENTS



Surgitech

CLASSIC, EXCLUSIVE & ELEGANCE STYLE SURGICAL INSTRUMENTS

KIDNEY TRANSPLANT
INSTRUMENTS



KTE - 0244

KTE - 0344

KTE - 0180

KTE - 0245

KTE - 0672

KTE - 0352

KTE - 0170

KTF - 0130

KTG - 4108

KTG - 0310

KTB - 0102

KTG - 0135

KTG - 6235, SC

KTE 0671

KTG - 6201, SC

KTC - 0322

KTB - 3630

KTB - 3620

KTF - 0361

KTE - 0208

KTC - 0342

KTE - 0654

KTG - 0123

KTF - 0360



Surgitech

CLASSIC, EXCLUSIVE & ELEGANCE STYLE SURGICAL INSTRUMENTS

KIDNEY TRANSPLANT
INSTRUMENTS

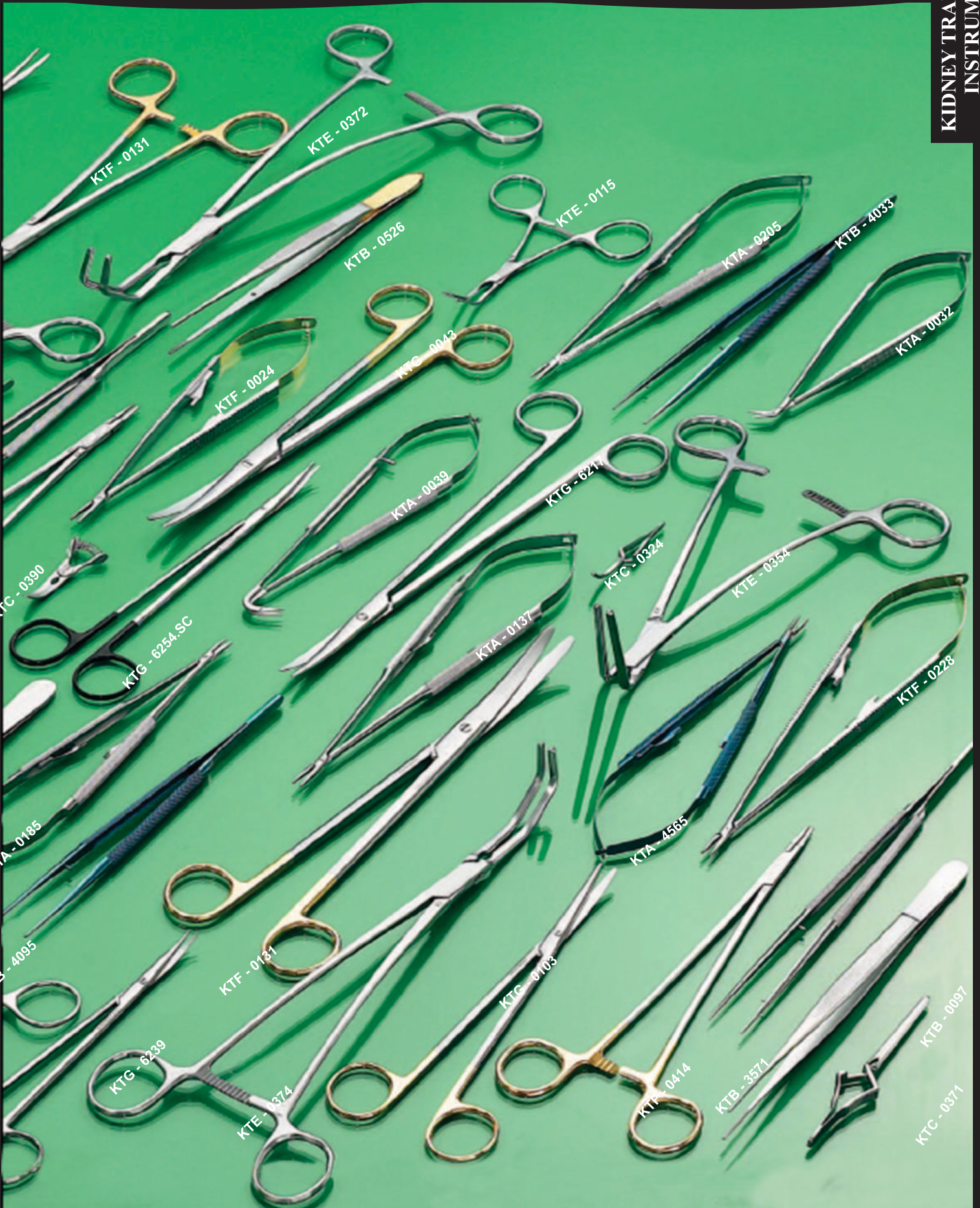



KIDNEY TRANSPLANT INDEX

Micro Instruments:

- KTA-0032 Jacobson Coronary Scissors 17cm 45° flat handle, standard 10mm blade
- KTA-0038 Jacobson Coronary Scissors 17cm 125° flat handle, standard 10mm blade
- KTA-0039 Jacobson Coronary Scissors 17cm 125° round handle, standard 10mm blade
- KTA-0135 Coronary Needle Holder 18cm 1.2mm straight with catch, wide round handle, jaws
- KTA-0137 Coronary Needle Holder 21cm 1.2mm straight with catch, wide round handle, jaws
- KTA-0185 Micro Needle Holder 18cm 0.8mm straight with catch, round handle, jaws
- KTA-0205 Micro Needle Holder 20.5cm 0.8mm straight with catch, round handle, jaws
- KTA-4565 Titanium Needle Holder 18cm 0.8mm straight with catch, round handle, jaws

Tissue Forceps:

- KTA-0097 Micro-DeBakey - Diethrich Tiss Fcps 19.5cm extra fine 1mm tip
- KTA-0102 DeBakey - Diethrich Tissue Forceps 19.5cm 1.5mm
- KTA-0112 DeBakey Tissue Forceps 19.5cm 2.0mm
- KTA-0252 Resano Valve Grasping Tiss Forceps 23cm
- KTA-0526 Potts-Smith Forceps 18cm w/dissector TC
- KTA-3571 Micro Tying Forceps 21cm str 0.8mm jaws
- KTA-3620 Micro Ring Forceps 18cm str 0.5x1.0mm jaws
- KTA-3630 Micro Ring Forceps 21cm str 0.5x1.0mm jaws
- KTA-4033 Titanium Ring Fcps 0.5x1.0mm 21cm jaws
- KTA-4095 Titanium Micro Atraum. Fcps 1mm 18cm

Bulldog Clamps:

- KTA-0208 Featherlight Bulldog Clamp straight 18mm
- KTA-0310 Diethrich Micro Bulldog 5cm 8mm angled
- KTA-0311 Diethrich Micro Bulldog 5cm 12mm angled
- KTA-0312 Diethrich Micro Bulldog 5cm 16mm angled
- KTA-0322 DeBakey - Diethrich Bulldog 5.5cm 20mm straight
- KTA-0324 DeBakey - Diethrich Bulldog 5.5cm 20mm curved
- KTA-0371 Gregory Bulldog Clamp straight 11cm
- KTA-0390 Glover Bulldog Clamp curved 5cm

Atraumatic Vascular Clamps:

- KTA-0104 DeBakey Ring-Bulldog Clamp ang. 12.5cm
- KTA-0115 Noon A-V Fistula Clamp ang. 11cm
- KTA-0171 DeBakey Peripheral Vasc Clamp 26.5cm cvd heavy pattern
- KTA-0180 DeBakey Peripheral Vasc Clamp 19cm cvd. regular pattern
- KTA-0244 Kay Aortic Clamp 20cm

Atraumatic Vascular Clamps cont.:

- KTA-0245 Lambert-Kay Aortic Clamp 20cm
- KTA-0342 DeBakey Multi-Purpose Clamp Fig.2 20.5cm
- KTA-0344 DeBakey Multi-Purpose Clamp Fig.3 24cm

- KTA-0352 DeBakey Multi-Purpose Clamp Fig.2 18cm
- KTA-0354 DeBakey Multi-Purpose Clamp Fig.3 21.5cm
- KTA-0372 DeBakey Tangential Occlusion Clamp 25cm
- KTA-0374 DeBakey Tangential Occlusion Clamp 26cm
- KTA-0651 Gregory Profunda Clamp (Std-Adult) 18cm
- KTA-0671 Cooley - Derra Anastomosis Clamp 17cm
- KTA-0672 Cooley - Derra Anastomosis Clamp 17.5cm

Needle Holders:

- KTA-0130 Mayo - Hegar Needle Holder 16cm TC (N)
- KTA-0131 Mayo - Hegar Needle Holder 18cm TC (N)
- KTA-0224 Castroviejo Needle Holder 18cm with catch straight TC (M)
- KTA-0228 Castroviejo Needle Holder 21cm with catch straight TC (M)
- KTA-0360 DeBakey Needle Holder 18cm TC (F)
- KTA-0361 DeBakey Needle Holder 20cm TC (F)
- KTA-0412 Mini-Ryder Needle Holder 15cm TC (M)
- KTA-0413 Mini-Ryder Needle Holder 18cm TC (M)
- KTA-0414 Mini-Ryder Needle Holder 20cm TC (M)

Scissors:

- KTA-0026 TC Mayo Scissors curved 23cm
- KTA-0043 TC Mayo - Lexer Scissors curved 21cm
- KTA-0103 TC Metzenbaum Scissors curved 18cm
- KTA-0123 TC Metzenbaum Fino Scissors cvd. 18cm
- KTA-4102 Diethrich - Hegemann Scissors 18cm 45°
- KTA-4108 Diethrich - Hegemann Scissors 18cm 125°
- KTA-6201 SC Metzenbaum Diss Scissors 18cm curved, Super Cut
- KTA-6217 Metzenbaum - Fino Scissors 23cm curved
- KTA-6239 Jameson Scissors 15cm curved fine tip
- KTA-6254, SC Reynolds Scissors 18.0cm curved, Duro Edges
- KTA-6255, SC Jameson Scissors 18.0cm curved, Duro Edges